

LED
WALL WASHER
LIGHT

HALINE



Name: HALINE LED R2

Code: W24

THORN

Led Wall Washer

DC 24V	BICOLOR				DMX 8pixel	DMX 512	RoHS	CE	IP 66	IK 08	
--------	---------	--	--	--	------------	---------	------	----	-------	-------	--

T Shape Bracket Size: 1000x24.5x63.2mm(L*W*H) **Net Weight:** 0.8kg

L=1000/500/300mm

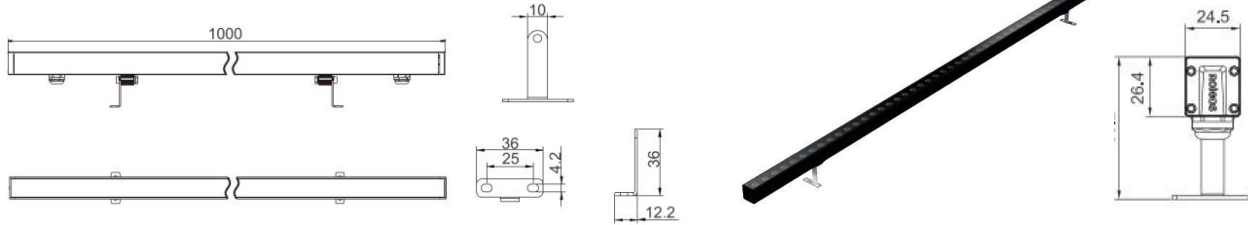

MODEL NO.	LEDs (PCS)	POWER (W)	BEAM ANGLE (°)	CCT (K)	LUMEN (Lm)	EFFICACY (Lm/W)
HALINE LED R2 W24	48	11	30°/45°/25x45°	2700-6500K	675-787.5	45-52.5
		11		RGB	228-252	19-20.5
		14		RGBW	328.2-384	23.4-24.3

FINISH

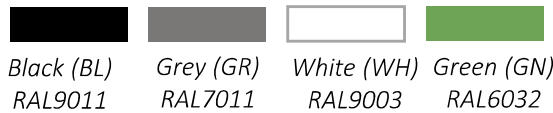

LIGHT DISTRIBUTION

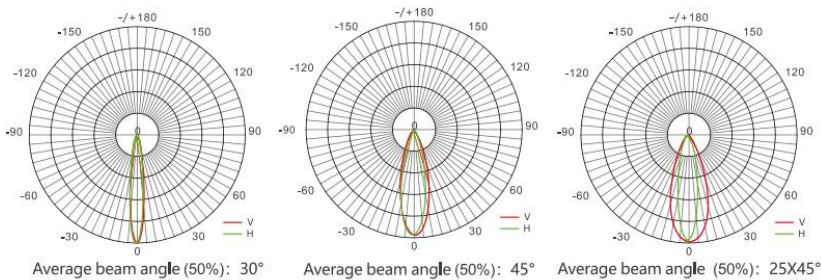

ACCESSORIES



Grille Louvre Light Baffle T-Shape bracket

Name: HALINE LED R2

Code: W33

THORN

Led Wall Washer

	DC 24V				DMX 8pixel	DMX 512	RoHS	CE	IP 66	IK 08	
--	--------	--	--	--	------------	---------	------	----	-------	-------	--

T Shape Bracket Size: 1000x33x57.8mm(L*W*H) **Net Weight:**1.2kg

L=1000/500/300mm

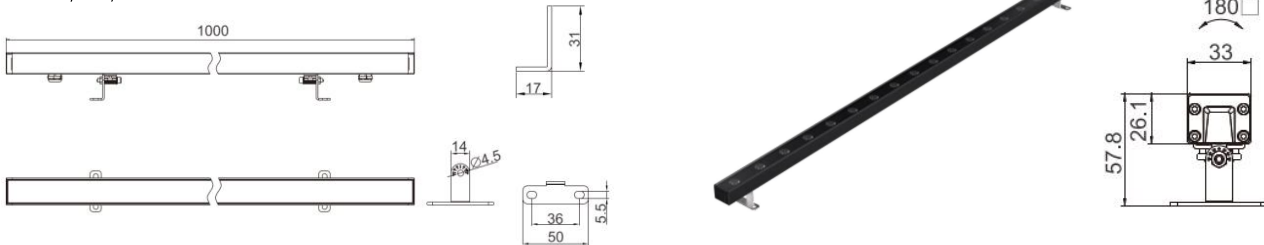

MODEL NO.	LEDs (PCS)	POWER (W)	BEAM ANGLE (°)	CCT (K)	LUMEN (Lm)	EFFICACY (Lm/W)
HALINE LED R2 W33	18	18	20°/30°/45° /20x40°	2700-6500K	1937.9-2036.7	108-113
	24	24			2334.3-2500	97-104

FINISH

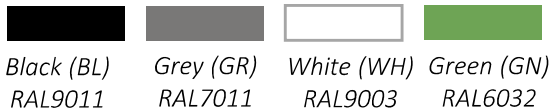

LIGHT DISTRIBUTION

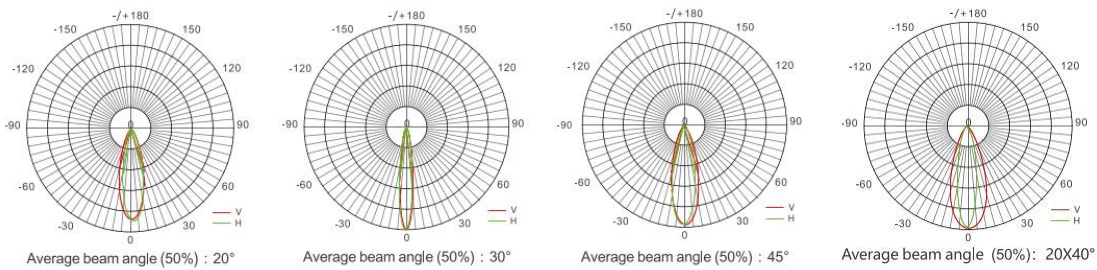

ACCESSORIES

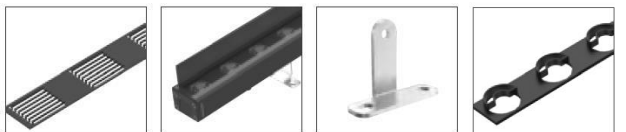

Grille Louvre Light Baffle T-Shape bracket Semicircle bullseye Louvre

Name: HALINE LED R2

Code: W38

THORN

Led Wall Washer

DC 24V	BICOLOR			DMX 8pixel	DMX 512	RoHS	CE	IP 66	IK 08	
--------	---------	--	--	------------	---------	------	----	-------	-------	--

T Shape Bracket Size: 1000x38x57.2mm(L*W*H) Net Weight:1.5kg

L=1000/500/300mm

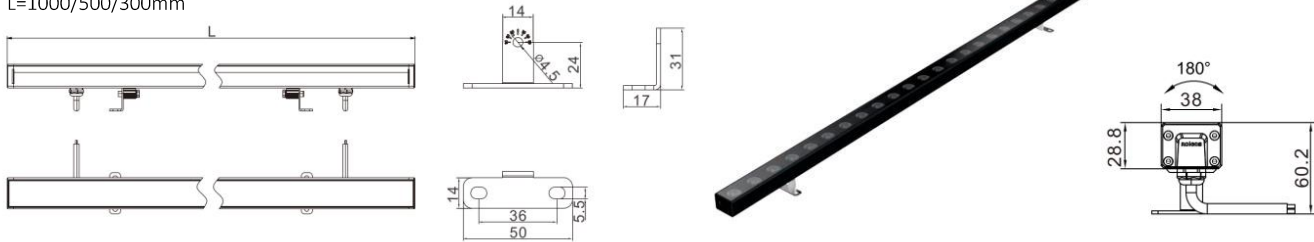

MODEL NO.	LEDs (PCS)	POWER (W)	BEAM ANGLE (°)	CCT (K)	LUMEN (Lm)	EFFICACY (Lm/W)	
HALINE LED R2 W38	24	24	7°/15°/30°/45° /15x60°/20x40°	2700-6500K	2121.6-2735	86-114	
	16		15°/30°/45° /15x60°/20x40°	RGB3in1	768-780	32-32.5	
	16	RGBW4in1		912-932	38-40.5		
	36	36	7°/15°/30°/45° /15x60°/20x40°	2700-6500K	2909.7-3833	81-106	
	16			RGB3in1	1260-1440	44.5-45	
	16			RGBW4in1	1764-1787	49-50	
	24	48	48	7°/15°/30°/45° /15x60°/20x40°	2700-6500K	4128-4145	86-87
	16	15°/30°/45° /15x60°/20x40°		RGBW4in1	1872-1902	39-40.5	

FINISH

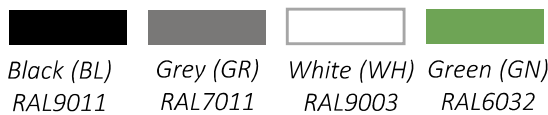

LIGHT DISTRIBUTION

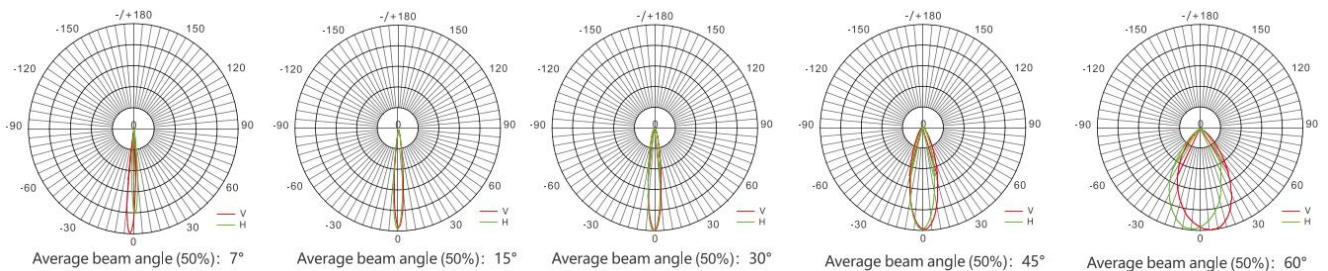

ACCESSORIES



Grille Louvre Light Baffle T-Shape bracket

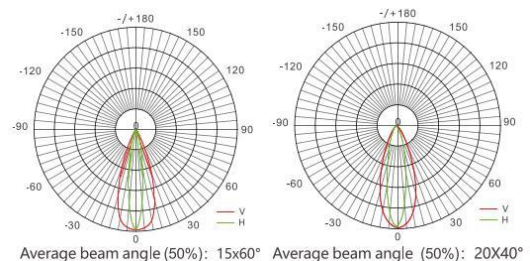

Name: HALINE LED R2

Code: W65

THORN

Led Wall Washer



T Shape Bracket Size: 1000x65x116mm(L*W*H) Net Weight:3.5kg

L=1000/500/300mm

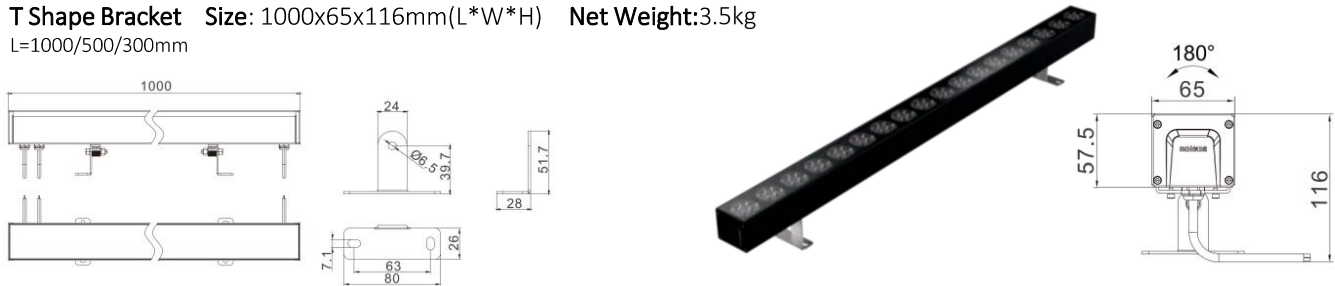

MODEL NO.	LEDs (PCS)	POWER (W)	BEAM ANGLE (°)	CCT (K)	LUMEN (Lm)	EFFICACY (Lm/W)
HALINE LED R2 W65	90	48	15°/22°/45°	5in1	2784-2904	58-60.5
	126	60	15°/22°/45°	7in1	3720-4028.4	62-68.9
			7°/15°/22°/30°/45° /60°/15x60°/20x40°	2700-6000K	4187-4205	69.8-70.1
				RGB	1497-1521	25-25.4
				RGBW	2086-2121	34.8-35.4

FINISH

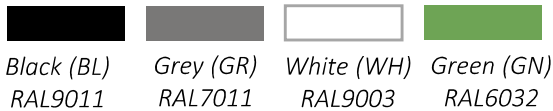

LIGHT DISTRIBUTION

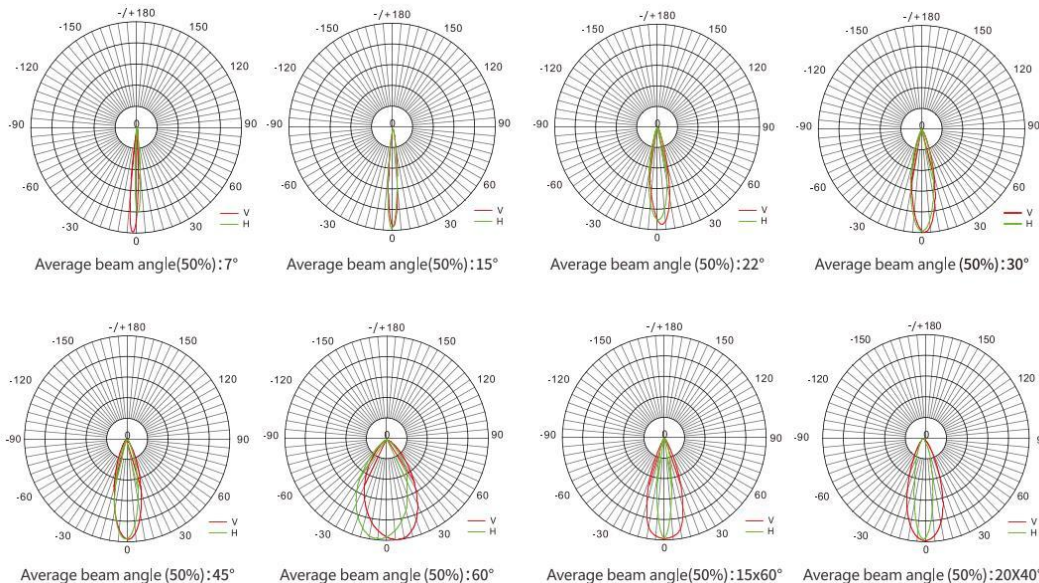





ACCESSORIES



Grille Louvre Light Baffle T-Shape bracket

OPTICAL ACCESSORIES

No.	Image	Optical Accessories	HALINE LED R2			
			W24	W33	W38	W65
A5		<i>Grille Louvre</i>	W24.A5	W33.A5	W38.A5	W65.A5
A6		<i>Light Baffle</i>	W24.A6	W33.A6	W38.A6	W65.A6
A7		<i>T-Shape bracket</i>	W24.A7	W33.A7	W38.A7	W65.A7
A8		<i>Semicircle bullseye Louvre</i>	-	W33.A8	-	-

LED
LINEAR LIGHT

HALINE



Name: HALINE R2

Code: W22W

THORN

Led wall washer

DC 24V				DMX 512	RoHS	CE	IP 66	IK 08	
-----------	---	---	---	------------	------	----	-------	-------	---

Size : 1000x22x27.3mm(L*W*H) Net Weight: 0.6kg

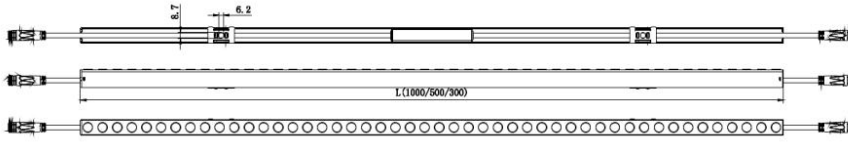

Size : 1000x22x27.3mm(L*W*H) Net Weight: 0.6kg

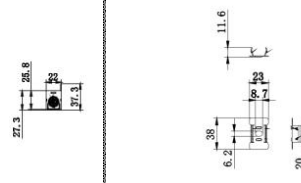
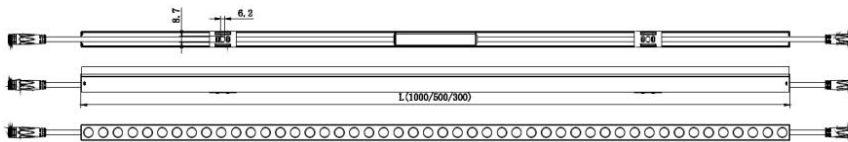

Size : 1000x22x27.3mm(L*W*H) Net Weight: 0.6kg

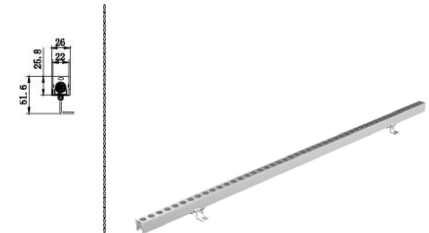
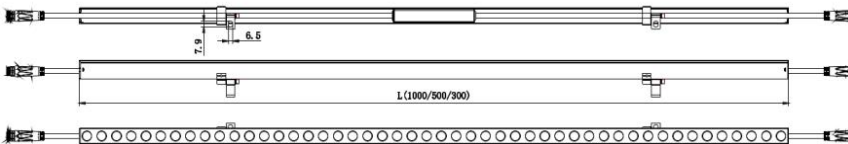

Size : 1000x22x27.3mm(L*W*H) Net Weight: 0.6kg

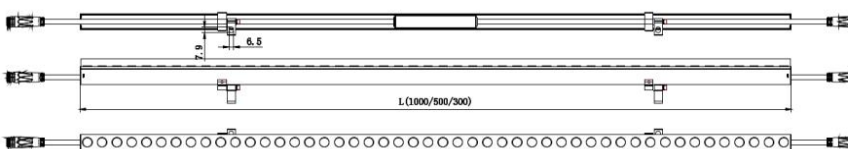

MODEL NO.	LEDs (PCS)	POWER (W)	BEAM ANGLE (°)	CCT (K)	LUMEN (LM)	EFFICACY (LM/W)
HALINE R2 W22W	48	12	30°/45° /25×45°	2700-5700K	750-782	63-65
		12		RGB	206-208	17-18
		15		RGBW	355	24

Name: HALINE R2

Code: W22W

THORN

Led wall washer

FINISH



Black (BL)
RAL9011



Grey (GR)
RAL7011



White (WH)
RAL9003



Green (GN)
RAL6032

LIGHT DISTRIBUTION

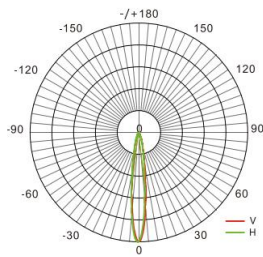

Beam Angle (FWHM): 30°

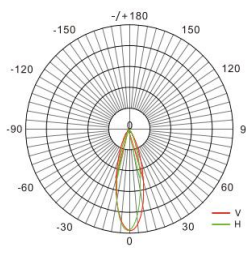

Beam Angle (FWHM): 45°

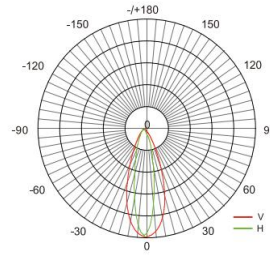

Beam Angle (FWHM): 25X45°

ACCESSORIES



Anti-glare Baffle



Clip bracket



Clip bracket



T-shape bracket

Name: HALINE R2

Code: W30W

THORN

Led wall washer

DC 24V		 2700-5700K	DMX 512	RoHS	CE	IP 66	IK 08	 -30~+45°C
-----------	--	----------------	------------	------	----	-------	-------	---------------

Size : 1000x45x31mm Net Weight: 1kg
L=995/660/300mm

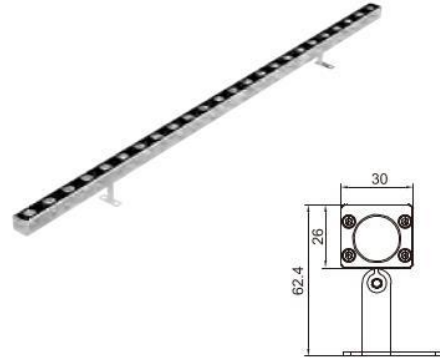
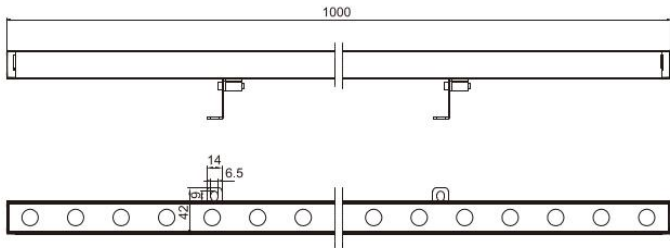

MODEL NO.	LEDs (PCS)	POWER (W)	BEAM ANGLE(°)	CCT (K)	LUMEN (LM)	EFFICACY (LM/W)
HALINE R2 W30W	24	24	20°/30°/45°/60° /20x40°	2700-5700K	1120-1810	47-75
			30°/45° /20x40°	RGBWH	490-650	20-27

FINISH



LIGHT DISTRIBUTION

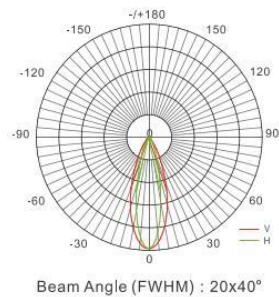
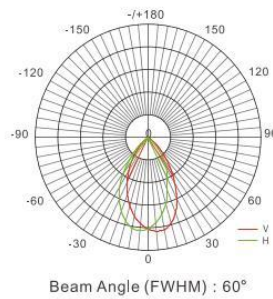
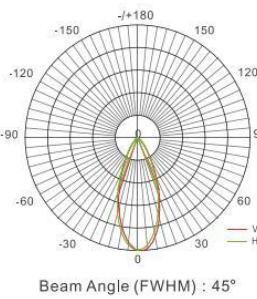
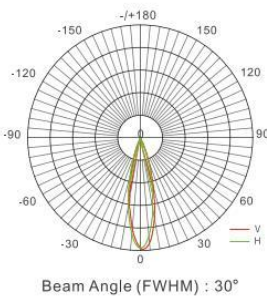
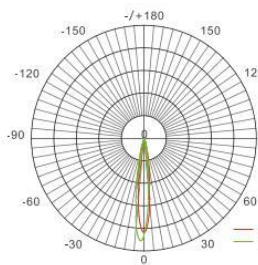

ACCESSORIES



Anti-glare Baffle(Y)



T-shape bracket

Name: HALINE R2

Code: W42W

THORN

Led wall washer

AC 220V	DC 48V	DC 24V			DMX 512	RoHS	CE	IP 66	IK 08	
------------	-----------	-----------	---	---	------------	------	----	-------	-------	---

Size: 75.94x50x1000mm **Net Weight:** 1.8kg
L=995/660/300mm

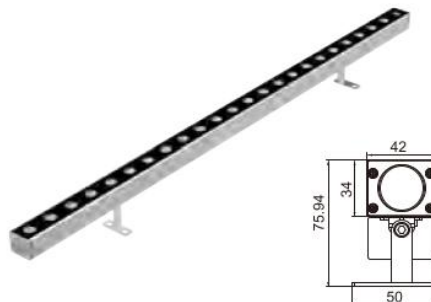
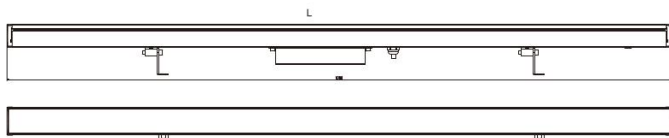

MODEL NO.	LEDs (PCS)	POWER (W)	BEAM ANGLE (°)	CCT (K)	LUMEN (LM)	EFFICACY (LM/W)
HALINE R2 W42W	24	36	8°	2700-6500K	2160-2520	60-70
	36		15°/30°/45°/60° /20x40°/15x60°		2016-2880	56-80
	24		20°/30°/45°/60° /20°x40°/15x60°	RGBW	1080-1368	30-38
	24	48	8°	2700-6500K	2880-3360	60-70
	36		15°/30°/45°/60° /20x40°/15x60°		2688-3840	56-80
	24		20°/30°/45°/60° /20x40°/15x60°	RGBW	1440-1824	30-38

FINISH



Black (BL)
RAL9011



Grey (GR)
RAL7011



White (WH)
RAL9003



Green (GN)
RAL6032

Name: HALINE R2

Code: W42W

THORN

Led wall washer

LIGHT DISTRIBUTION

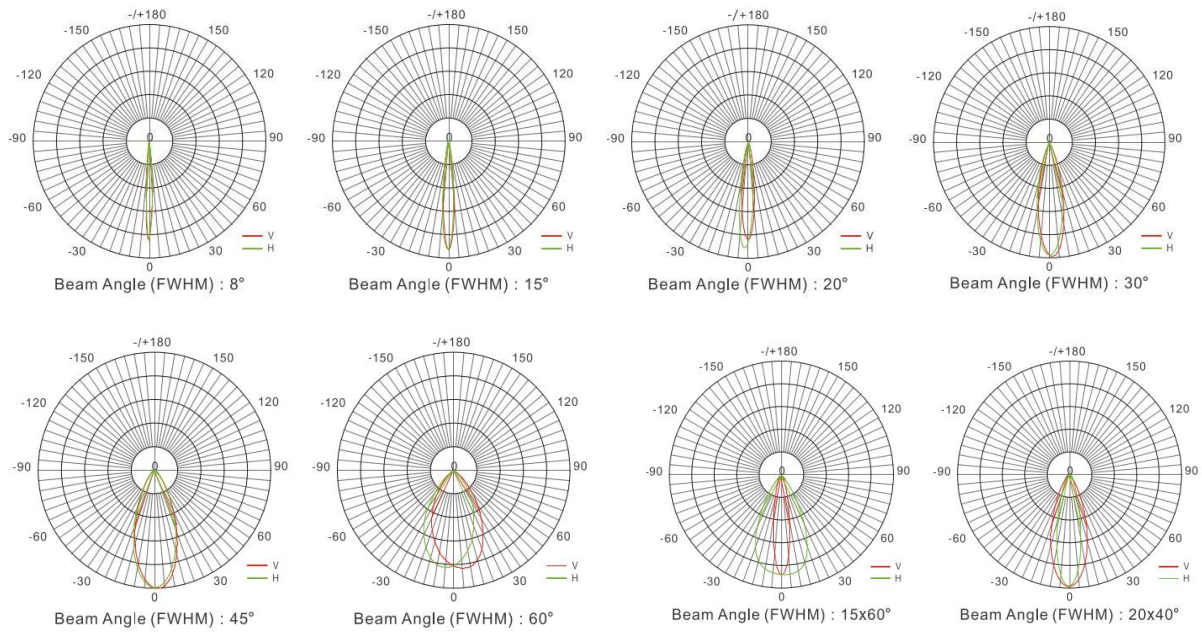

ACCESSORIES



Anti-glare Baffle(Y)



T-shape bracket



Name: HALINE R2

Code: W56W

THORN

Led wall washer

AC 220V	DC 24V		 2700-5700K	DMX 512	RoHS	CE	IP 66	IK 08	 -30~+45°C
------------	-----------	---	---	------------	------	----	-------	-------	--

Size: 1000x45x31mm Net Weight : 2.5kg
L=995/660/300mm

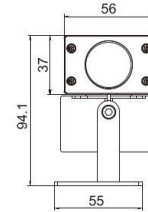
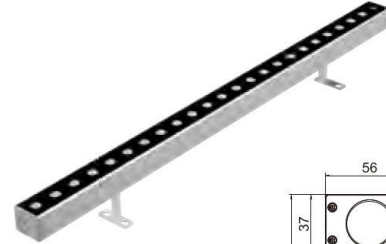
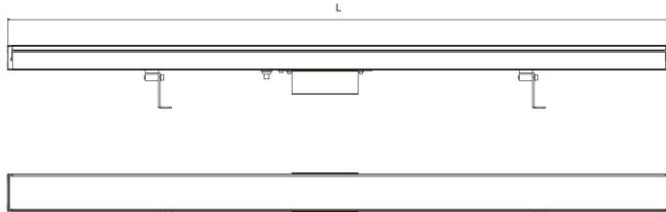

MODEL NO.	LEDs (PCS)	POWER (W)	BEAM ANGLE (°)	CCT (K)	LUMEN (LM)	EFFICACY (LM/W)
HALINE R2 W56W	30	60	8°/15°/30°/45°/60° /20x40°/15x60°	2700-6500K	3000-2160	50-72
	24		15°/30°/45° /20°x40°/15x60°	RGBWH	2160-2700	36-45
	36	72	8°/15°/30°/45°/60° /20x40°/15x60°	2700-6500K	3600-5184	50-72
	24		15°/30°/45° /20x40°/15x60°	RGBWH	2592-3240	36-45

FINISH



Black (BL)
RAL9011



Grey (GR)
RAL7011



White (WH)
RAL9003



Green (GN)
RAL6032

Name: HALINE R2

Code: W56W

THORN

Led wall washer

LIGHT DISTRIBUTION

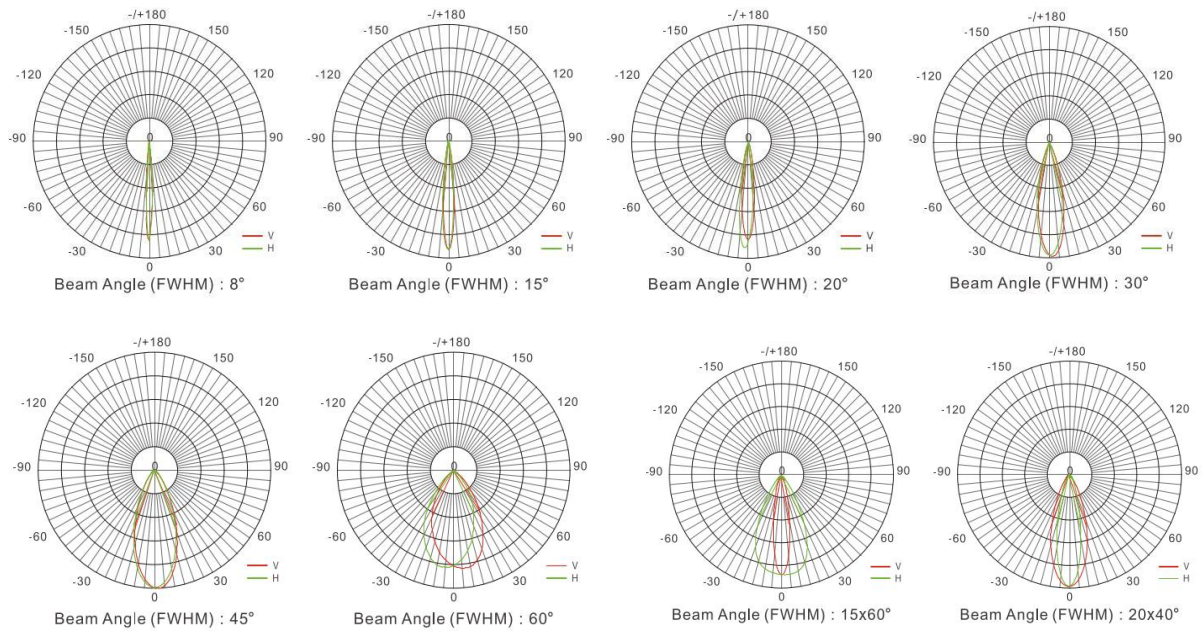

ACCESSORIES



Anti-glare Baffle(Y)



T-shape bracket





Name: HALINE R2

Code: W66W

THORN

Led wall washer

AC110V - 220V / AC220V				DMX 512	RoHS	CE	IP 66	IK 08	
------------------------	---	---	---	---------	------	----	-------	-------	---

Size: 1000x55x87.8mm Net Weight: 3.5kg
L=1000/500/300mm

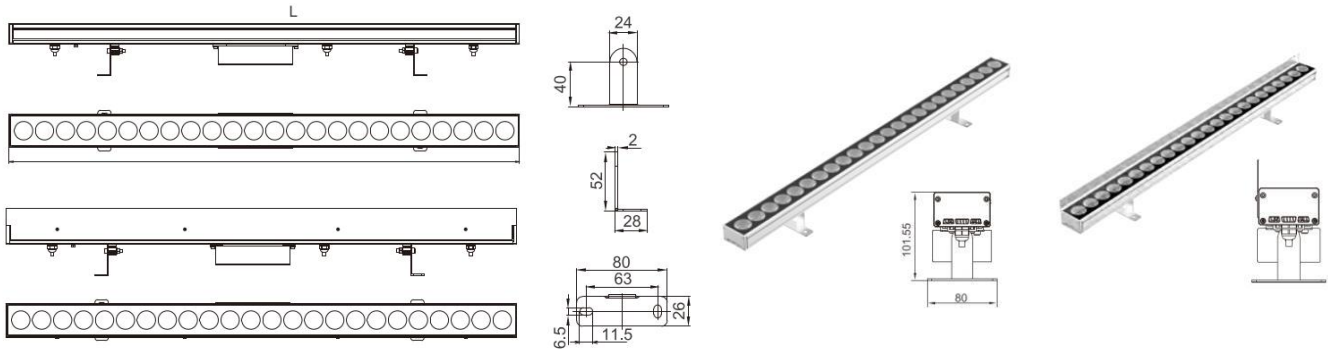

MODEL NO.	LEDs (PCS)	POWER (W)	BEAM ANGLE (°)	CCT (K)	LUMEN (LM)	EFFICACY (LM/W)
HALINE R2 W66W	24	60	3.5°	2700-6000K	4020-4380	67-73
			3.5°/8°	RGB	1980	33
		72	8°/15°/30°	4in1	2880-3310	40-46

FINISH



Black (BL)
RAL9011



Grey (GR)
RAL7011



White (WH)
RAL9003



Green (GN)
RAL6032

LIGHT DISTRIBUTION

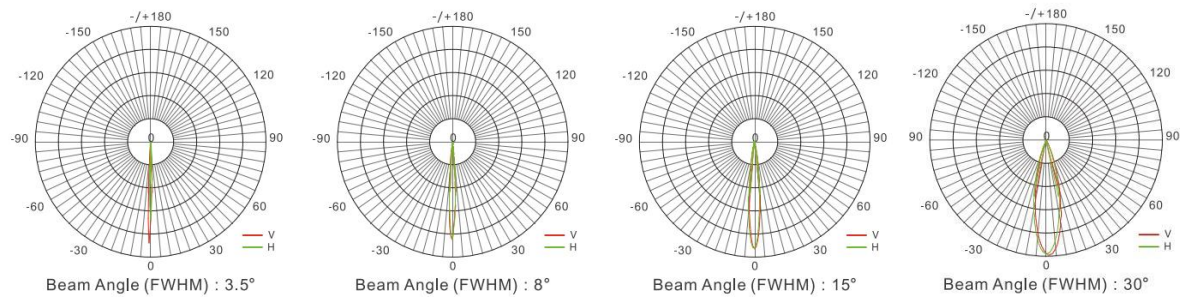

ACCESSORIES



Anti-glare Baffle(Y)



T-shape bracket

Name: HALINE R2

Code: W90W

THORN

Led wall washer

AC110V - 220V / AC220V	DC 24V				DMX 512	RoHS	CE	IP 66	IK 08	
------------------------	--------	--	--	--	---------	------	----	-------	-------	--

Size: 1000x95x117mm **Net Weight:** 4.9kg
L=1000/500/300mm

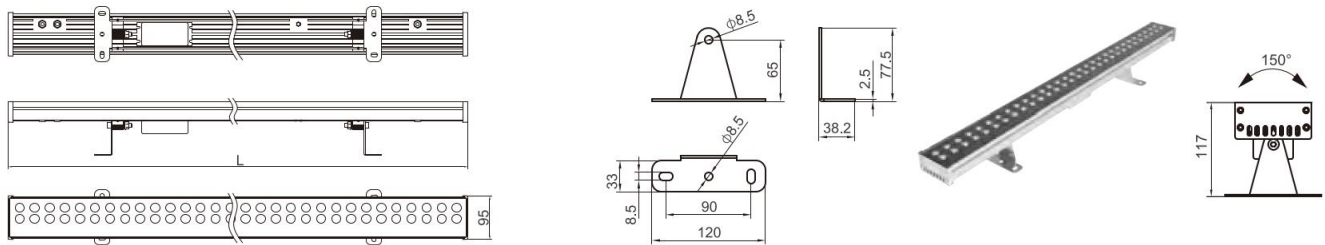

Size: 1000x95x177mm **Net Weight:** 5.2kg
L=1000/500/300mm

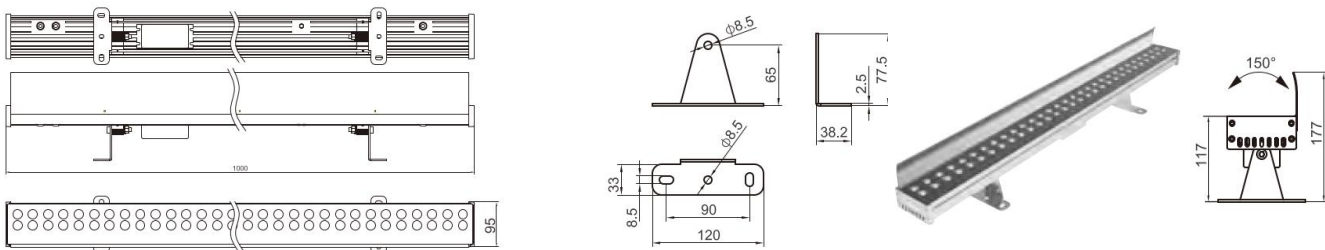

MODEL NO.	LEDs (PCS)	POWER (W)	BEAM ANGLE(°)	CCT (K)	LUMEN (LM)	EFFICACY (LM/W)
HALINE R2 W90W	60	120	7°/15°/30°/45° /60°/20x40° /15x60°	2700-6000K	8640-9000	72-75
				RGB	4320-4560	36-38
	64	120		RGBW	4560-4920	38-41

FINISH



Black (BL)
RAL9011



Grey (GR)
RAL7011



White (WH)
RAL9003



Green (GN)
RAL6032

Name: HALINE R2

Code: W90W

THORN

Led wall washer

LIGHT DISTRIBUTION

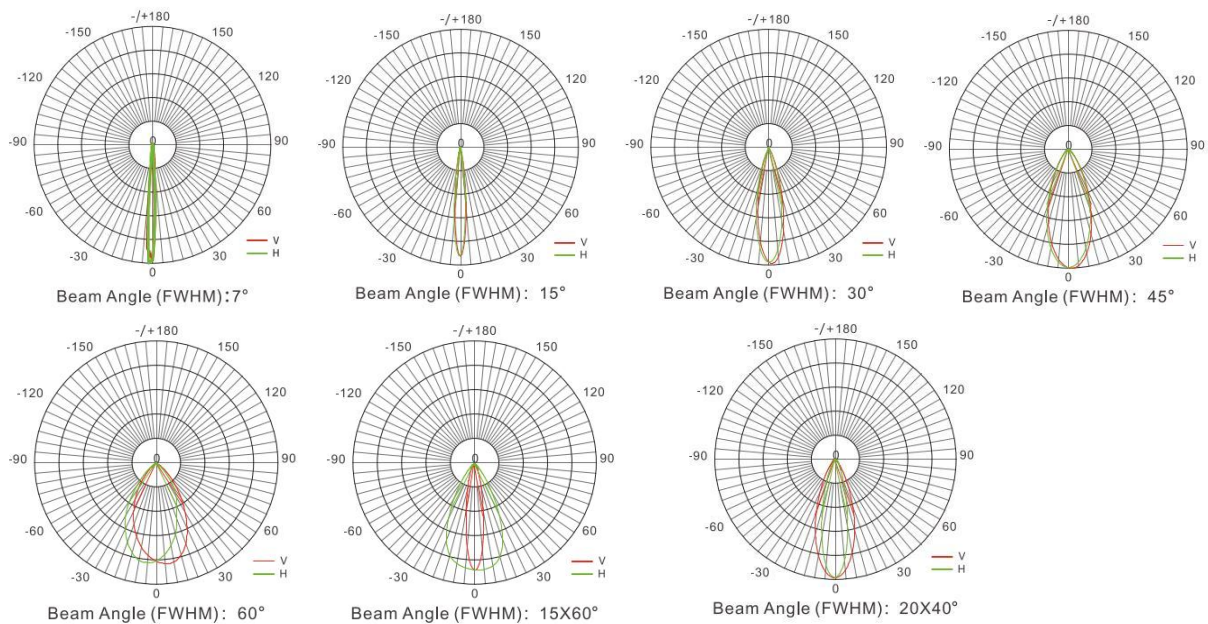

ACCESSORIES



T-shape bracket



Name: HALINE R2

Code: W100W

THORN

Led wall washer

DC 24V			DMX 512	RoHS	CE	IP 66	IK 08	
-----------	--	--	------------	------	----	-------	-------	--

Size: 1000x38x115mm Net Weight: 5.5kg
L=1000/500/300mm

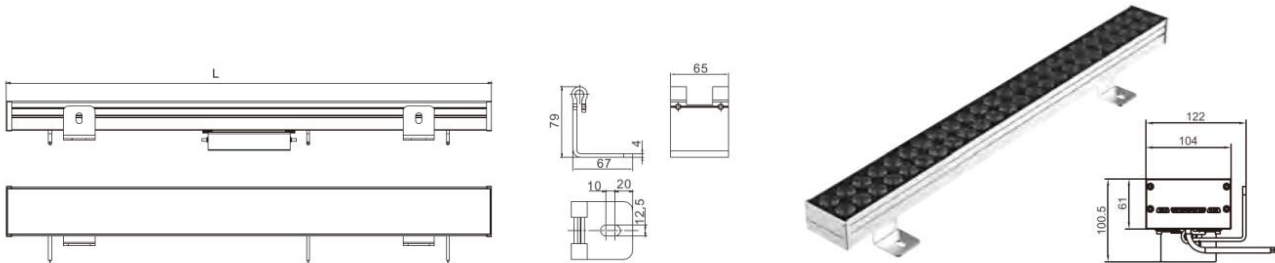

MODEL NO.	LEDs (PCS)	POWER (W)	BEAM ANGLE(°)	CCT (K)	LUMEN (LM)	EFFICACY (LM/W)
HALINE R2 W100W	48	120	3.5°	2700-6000K	8760-9480	73-79
			3.5°/8°	RGB	3840	32
	150	8°/15°/30°	RGBW 4in1	6150-7200	41-48	

FINISH



Black (BL)
RAL9011



Grey (GR)
RAL7011



White (WH)
RAL9003



Green (GN)
RAL6032

LIGHT DISTRIBUTION

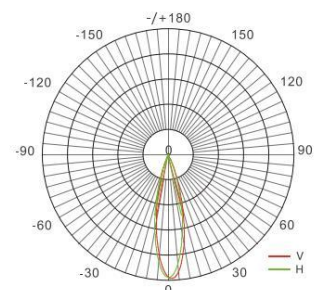
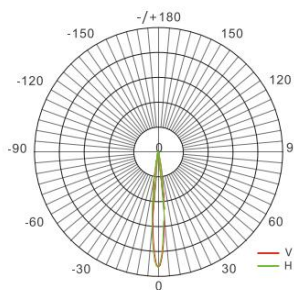
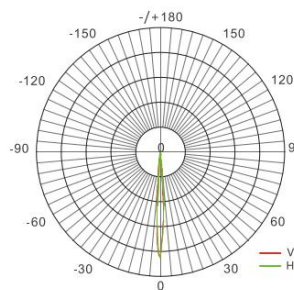
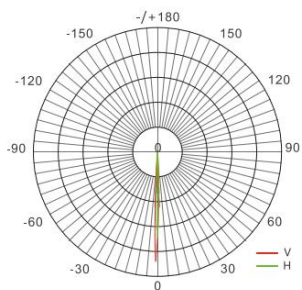

ACCESSORIES



Anti-glare Baffle(Y)



T-shape bracket

OPTICAL ACCESSORIES

No.	Image	Optical Accessories	HALINE LED R2						
			W22W	W30W	W42W	W56W	W66W	W90W	W100W
A17		Anti-glare Baffle	W22W.A 17-XX	-	-	-	-	-	-
A18		Clip bracket	W22W.A 18-XX	-	-	-	-	-	-
A19		Clip bracket	W22W.A 19-XX	-	-	-	-	-	-
A20		T-shape bracket	W22W.A 20-XX	-	-	-	-	-	-
A21		Anti-glare Baffle	-	W30W .A21-XX	W42W .A21-XX	W56W .A21-XX	W66W .A21-XX	-	W100W .A21-XX
A22		T-shape bracket	-	W30W .A22-XX	W42W .A22-XX	W56W .A22-XX	W66W .A22-XX	W90W .A22-XX	W100W .A22-XX