

Name: SEAN LED B2

Code: D280

THORN

LED Pool Light

CE	RoHS	CRI>80/90	IP 68	IK 08	T_a-20 +40
-----------	-------------	---------------------	--------------	--------------	---------------------------------

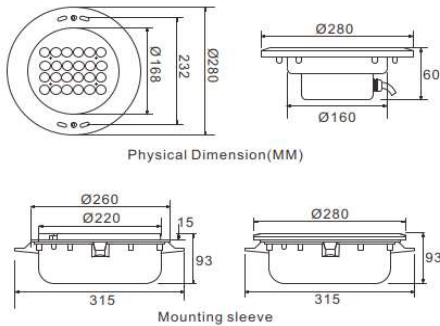

MODEL NO.	POWER	SYSTEM LUMEN	LED COLOR	BEAM ANGLE	INPUT VOLT	CONTROL
SEAN LED B2 D280	25W	30 lm/w	2800K-6500K/RGB	15°/30°/45° 15°*50°	AC/DC 12V/24V	DALI/1-10V Triac/PWM
SEAN LED B2 D280	35W	30 lm/w	2800K-6500K/RGB/RGBW			
SEAN LED B2 D280	50W	75 lm/w	2800K-6500K			
SEAN LED B2 D280	80W					

CUT HOLE	220*93mm/216*88mm/211*72mm(+3mm)
FINISH	<p>Front cover&Housing:Hard Chromeplated Molding Shaped Stainless steel SUS 316L#</p> <p>LED:CREE</p> <p>Lens: Optical lens, efficiency≥85%</p> <p>Glass:Step tempered glass.T=8mm</p> <p>Gasket:Tooling shaped seal</p> <p>Driver:Constant current output,Constant current output</p> <p>Power cable:3X1.0mm². L=2.5m(Monocolor AC/DC)</p> <p>3X1.0mm². L=2.5m(RGB , RGBW AC)</p> <p>4X1.0mm². L=2.5m(RGB DC)</p> <p>5X0.75mm². L=2.5m(RGBW DC)</p> <p>3X1.0mm²+3X1.0mm². L=2.5m(RGB , RGBW DMX512)</p> <p>Mounting sleeve:ABS/316L# Stainless Steel</p> <p>Dimmable Support:Triac/PWM/1-10V/DALI/DMX512</p>



MOUNTING

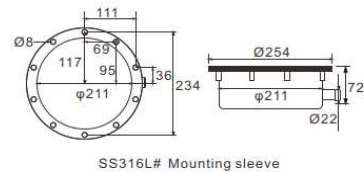

Name: SEAN LED B2

Code: D200

THORN

LED Pool Light

CE	RoHS	CRI>80/90	IP 68	IK 08	T_a-20 +40
-----------	-------------	---------------------	--------------	--------------	---------------------------------

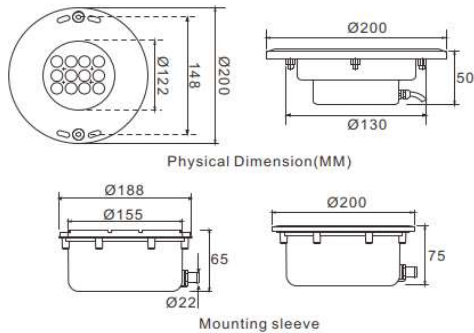

MODEL NO.	POWER	SYSTEM LUMEN	LED COLOR	BEAM ANGLE	INPUT VOLT	CONTROL
SEAN LED B2 D200	18W	30 lm/w	2800K-6500K/RGB/RGBW	15°/30°/45° 15°50°	AC/DC 12V/24V	DALI/1-10V Triac/PWM
SEAN LED B2 D200	25W					
SEAN LED B2 D200	35W	75 lm/w	2800K-6500K			

CUT HOLE	155*65mm/151*65mm/153*77mm(+3mm)
FINISH	<p>Front cover&Housing:Hard Chromeplated Molding Shaped Stainless steel SUS 316L#</p> <p>LED:CREE</p> <p>Lens: Optical lens, efficiency>85%</p> <p>Glass:Step tempered glass.T=8mm</p> <p>Gasket:Tooling shaped seal</p> <p>Driver:Constant current output,Constant current output</p> <p>Power cable:3X1.0mm2 . L=2.5m(Monocolor AC/DC)</p> <p>3X1.0mm2 . L=2.5m(RGB , RGBW AC)</p> <p>4X1.0mm2 . L=2.5m(RGB DC)</p> <p>5X0.75mm2 . L=2.5m(RGBW DC)</p> <p>3X1.0mm2+3X1.0mm2 . L=2.5m(RGB , RGBW DMX512)</p> <p>Mounting sleeve:ABS/316L# Stainless Steel</p> <p>Dimmable Support:Triac/PWM/1-10V/DALI/DMX512</p>

MOUNTING

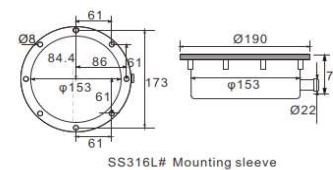

Name: SEAN LED B2

Code: D115

THORN

LED Pool Light

CE	RoHS	CRI>80/90	IP 68	IK 08	T _a -20 +40
-----------	-------------	-----------	-------	-------	---------------------------

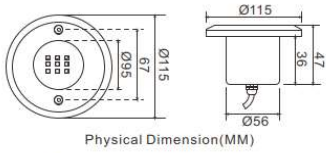

Physical Dimension(MM)

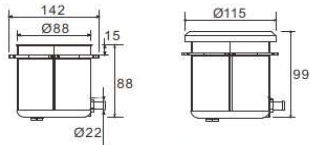

Mounting sleeve



MODEL NO.	POWER	SYSTEM LUMEN	LED COLOR	BEAM ANGLE	INPUT VOLT	CONTROL
SEAN LED B2 D115	12W	30 lm/w	2800K-6500K/RGB/RGBW	15°/30°/45° 15°50°	AC/DC 12V/24V	DALI/1-10V Triac/PWM
SEAN LED B2 D115	18W	30 lm/w	2800K-6500K/RGB			
SEAN LED B2 D115	25W	75 lm/w	2800K-6500K			

CUT HOLE	88*88mm/95*75mm(+3mm)
FINISH	<p>Front cover&Housing:Hard Chromeplated Molding Shaped Stainless steel SUS 316L#</p> <p>LED:CREE</p> <p>Lens: Optical lens, efficiency≥85%</p> <p>Glass:Step tempered glass.T=8mm</p> <p>Gasket:Tooling shaped seal</p> <p>Driver:Constant current output,Constant current output</p> <p>Power cable:3X1.0mm2 . L=2.5m(Monocolor AC/DC)</p> <p>3X1.0mm2 . L=2.5m(RGB , RGBW AC)</p> <p>4X1.0mm2 . L=2.5m(RGB DC)</p> <p>5X0.75mm2 . L=2.5m(RGBW DC)</p> <p>3X1.0mm2+3X1.0mm2 . L=2.5m(RGB , RGBW DMX512)</p> <p>Mounting sleeve:ABS/316L# Stainless Steel</p> <p>Dimmable Support:Triac/PWM/1-10V/DALI/DMX512</p>

MOUNTING

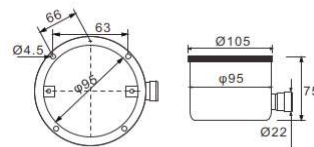

SS316L# Mounting sleeve



Name: SEAN LED B2

Code: D190

THORN

LED Pool Light

CE	RoHS	CRI>80/90	IP 68	IK 08	T _a -20 +40
-----------	-------------	-----------	-------	-------	---------------------------

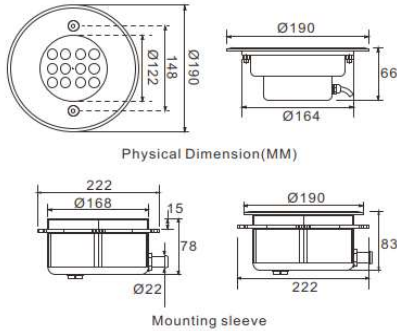

MODEL NO.	POWER	SYSTEM LUMEN	LED COLOR	BEAM ANGLE	INPUT VOLT	CONTROL
SEAN LED B2 D190	12W	30 lm/w	2800K-6500K/RGB	15°/30°/45°/60°	AC/DC 12V/24V	DALI/1-10V Triac/PWM
SEAN LED B2 D190	18W	30 lm/w	2800K-6500K/RGB/RGBW			
SEAN LED B2 D190	25W	30 lm/w	2800K-6500K/RGB			
SEAN LED B2 D190	15W			100°		

CUT HOLE	168*78mm (+3mm)
FINISH	<p>Front cover&Housing:Hard Chromeplated Molding Shaped Stainless steel SUS 316L#/304L# LED:CREE,EPISTAR Lens: Optical lens, efficiency≥85% Glass:Step tempered glass.T=8mm Gasket:Tooling shaped seal Driver:Constant current output,Constant current output Power cable:3X1.0mm2. L=1.5m Mounting sleeve:ABS Dimmable Support:Triac/PWM/1-10V/DALI/DMX512</p>

MOUNTING



BL-SS19015S



Name: SEAN LED B2

Code: D160

THORN

LED Pool Light

CE	RoHS	CRI>80/90	IP 68	IK 08	T _a -20 +40
-----------	-------------	-----------	-------	-------	---------------------------

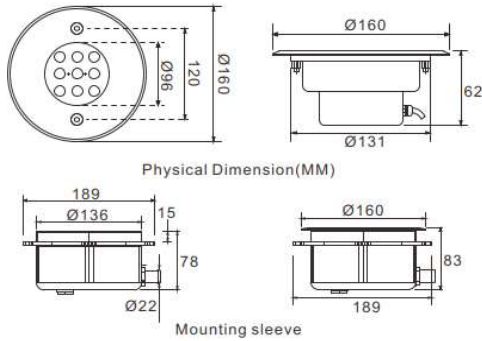

MODEL NO.	POWER	SYSTEM LUMEN	LED COLOR	BEAM ANGLE	INPUT VOLT	CONTROL
SEAN LED B2 D160	9W	30 lm/w	2800K-6500K/RGB	15°/30°/45°/60°	AC/DC 12V/24V	DALI/1-10V Triac/PWM
SEAN LED B2 D160	18W	30 lm/w	2800K-6500K/RGB/RGBW			
SEAN LED B2 D160	10W	30 lm/w	2800K-6500K/RGB	100°		

CUT HOLE	136*78mm (+3mm)
FINISH	<p>Front cover&Housing:Hard Chromeplated Molding Shaped Stainless steel SUS 316L#/304L#</p> <p>LED:CREE,EPISTAR</p> <p>Lens: Optical lens, efficiency>85%</p> <p>Glass:Step tempered glass.T=8mm</p> <p>Gasket:Tooling shaped seal</p> <p>Driver:Constant current output,Constant current output</p> <p>Power cable:3X1.0mm². L=1.5m</p> <p>Mounting sleeve:ABS</p> <p>Dimmable Support:Triac/PWM/1-10V/DALI/DMX512</p>

MOUNTING



Name: SEAN LED B2

Code: D195

THORN

LED Pool Light

CE	RoHS	CRI>80/90	IP 68	IK 08	T_a-20 +40
-----------	-------------	---------------------	--------------	--------------	---------------------------------

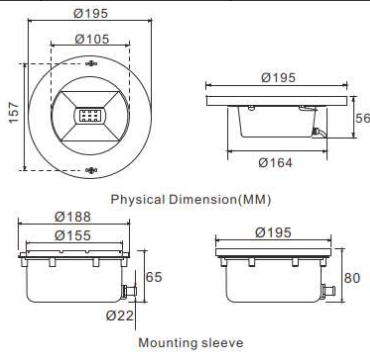

MODEL NO.	POWER	SYSTEM LUMEN	LED COLOR	BEAM ANGLE	INPUT VOLT	CONTROL
SEAN LED B2 D195	18W	30 lm/w	2800K-6500K/RGB/RGBW	90°	AC/DC 12V/24V	DALI/1-10V Triac/PWM
SEAN LED B2 D195	25W					
SEAN LED B2 D195	35W	30 lm/w	2800K-6500K/RGB			

CUT HOLE	155*65mm/151*65mm (+3mm)
FINISH	<p>Front cover&Housing:Hard Chromeplated Molding Shaped Stainless steel SUS 316L#/304L#</p> <p>LED:CREE</p> <p>Lens: Optical lens, efficiency>85%</p> <p>Glass:Step tempered glass.T=6mm</p> <p>Gasket:Tooling shaped seal</p> <p>Driver:Constant current output,Constant current output</p> <p>Power cable:3X1.0mm². L=1.5m</p> <p>Mounting sleeve:ABS</p> <p>Dimmable Support:Triac/PWM/1-10V/DALI/DMX512</p>

MOUNTING

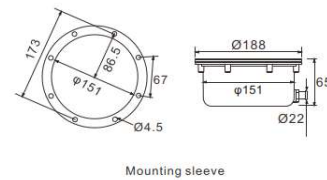

Name: SEAN LED B2

Code: D270

THORN

LED Pool Light

CE	RoHS	CRI>80/90	IP 68	IK 08	T _a -20 +40
-----------	-------------	-----------	-------	-------	---------------------------

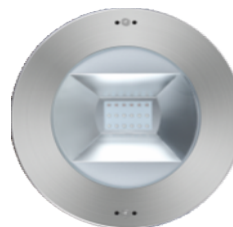
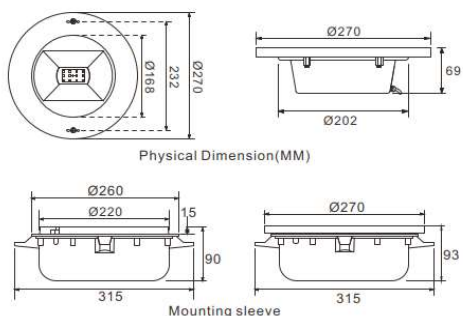

MODEL NO.	POWER	SYSTEM LUMEN	LED COLOR	BEAM ANGLE	INPUT VOLT	CONTROL
SEAN LED B2 D270	18W	30 lm/w	2800K-6500K/RGB/RGBW	90°	AC/DC 12V/24V	DALI/1-10V Triac/PWM
SEAN LED B2 D270	25W					
SEAN LED B2 D270	35W	30 lm/w	2800K-6500K/RGB			

CUT HOLE	220*90mm/216*88mm(+3mm)
FINISH	<p>Front cover&Housing:Hard Chromeplated Molding Shaped Stainless steel SUS 316L#/304L#</p> <p>LED:CREE</p> <p>Lens: Optical lens, efficiency>85%</p> <p>Glass:Step tempered glass.T=6mm</p> <p>Gasket:Tooling shaped seal</p> <p>Driver:Constant current output,Constant current output</p> <p>Power cable:3X1.0mm2. L=1.5m</p> <p>Mounting sleeve:ABS</p> <p>Dimmable Support:Triac/PWM/1-10V/DALI/DMX512</p>

MOUNTING

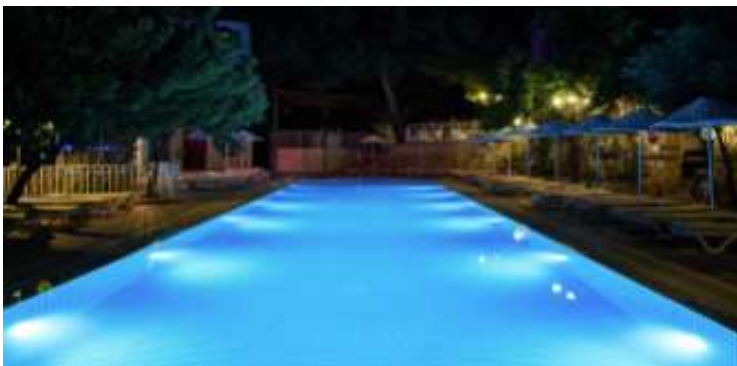
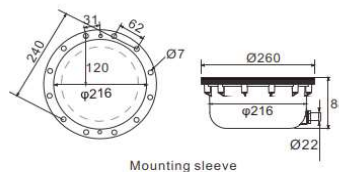

Name: SEAN LED B2

Code: D250

THORN

LED Pool Light

CE	RoHS	CRI>80/90	IP 68	IK 08	T _a -20 +40
-----------	-------------	-----------	-------	-------	---------------------------

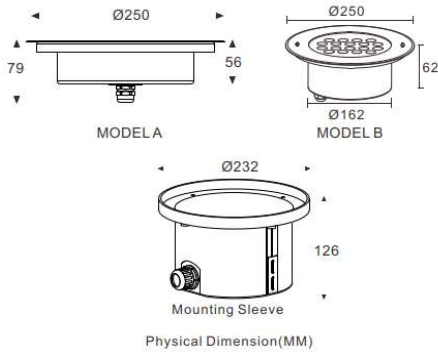

MODEL NO.	POWER	SYSTEM LUMEN	LED COLOR	BEAM ANGLE	INPUT VOLT	CONTROL
SEAN LED B2 D250	18Wx2W	30 lm/w	2700-6500K R/G/B	15°/30°/ 45°/ 60,45/35°	DC24V	DALI/1-10V Triac/PWM
SEAN LED B2 D250	18x3W	30 lm/w	RGB 3in1,DMX512			
SEAN LED B2 D250	18x4W	30 lm/w	RGBW 4in1,DMX512	15°/30°/45°/60°		

CUT HOLE	232*126mm(+3mm)
FINISH	<p>Front cover&Housing:Hard Chromeplated Molding Shaped Stainless steel SUS 316L# LED:CREE/OSRAM Lens: Optical lens, efficiency>85% Glass:Step tempered glass.T=8mm Gasket:Tooling shaped seal Driver:Constant current output,Constant current output Power cable:H07RN-F 2X1.0mm2. L=3m(low voltage) H05RN-F 4X0.75mm2. L=3m(RGB) H05RN-F 5X0.5mm2. L=3m(RGB 3in1, RGBW 4in 1 DMX512) Mounting sleeve:ABS. Dimmable Support:Triac/PWM/1-10V/DALI/DMX512</p>

MOUNTING

With Bracket



Name: SEAN LED B2

Code: D205

THORN

LED Pool Light

CE	RoHS	CRI>80/90	IP 68	IK 08	T _a -20 +40
-----------	-------------	-----------	-------	-------	---------------------------

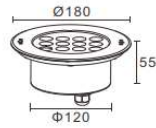
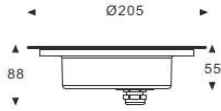

MODEL A

MODEL B



MODEL NO.	POWER	SYSTEM LUMEN	LED COLOR	BEAM ANGLE	INPUT VOLT	CONTROL
SEAN LED B2 D205	12x2W	30 lm/w	2700-6500K R/G/B	15°/30°/ 45°/ 60,45/35°	DC24V	DALI/1-10V Triac/PWM
SEAN LED B2 D205	12x3W	30 lm/w	RGB 3in1,DMX512			
SEAN LED B2 D205	12x4W	30 lm/w	RGBW 4in1,DMX512	15°/30°/45°/60°		
SEAN LED B2 D205	1x25W	75 lm/w	2700-6500K	24°/36°/60°		

CUT HOLE	169*126mm(+3mm)
FINISH	<p>Front cover&Housing:Hard Chromeplated Molding Shaped Stainless steel SUS 316L#</p> <p>LED:CREE/OSRAM</p> <p>Lens: Optical lens, efficiency≥85%</p> <p>Glass:Step tempered glass.T=8mm</p> <p>Gasket:Tooling shaped seal</p> <p>Driver:Constant current output,Constant current output</p> <p>Power cable:H07RN-F 2X1.0mm2. L=3m(low voltage) H05RN-F 4X0.75mm2. L=3m(RGB) H05RN-F 5X0.5mm2. L=3m(RGB 3in1, RGBW 4in 1 DMX512)</p> <p>Mounting sleeve:ABS.</p> <p>Dimmable Support:Triac/PWM/1-10V/DALI/DMX512</p>

MOUNTING

With Bracket



Name: SEAN LED B2

Code: D180

THORN

LED Pool Light

CE	RoHS	CRI>80/90	IP 68	IK 08	T _a -20 +40
----	------	-----------	-------	-------	---------------------------

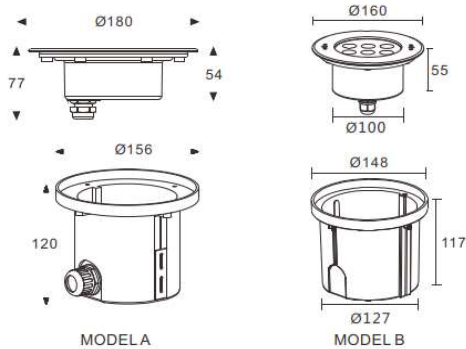

MODEL NO.	POWER	SYSTEM LUMEN	LED COLOR	BEAM ANGLE	INPUT VOLT	CONTROL
SEAN LED B2 D180	6x2W	30 lm/w	2700-6500K R/G/B	15°/30°/ 45°/ 60,45/35°	DC24V	DALI/1-10V Triac/PWM
SEAN LED B2 D180	6x3W	30 lm/w	RGB 3in1,DMX512		DC24V External DMX Chip	
SEAN LED B2 D180	6x4W	30 lm/w	RGBW 4in1,DMX512	15°/30°/45°/60°		
SEAN LED B2 D180	1x15W	75 lm/w	2700-6500K	24°/36°/60°	DC24V	

CUT HOLE	156*120mm(+3mm)
FINISH	<p>Front cover&Housing:Hard Chromeplated Molding Shaped Stainless steel SUS 316L#</p> <p>LED:CREE/OSRAM</p> <p>Lens: Optical lens, efficiency≥85%</p> <p>Glass:Step tempered glass.T=8mm</p> <p>Gasket:Tooling shaped seal</p> <p>Driver:Constant current output,Constant current output</p> <p>Power cable:H07RN-F 2X1.0mm2. L=3m(low voltage)</p> <p style="padding-left: 20px;">H05RN-F 4X0.75mm2. L=3m(RGB)</p> <p style="padding-left: 20px;">H05RN-F 5X0.5mm2. L=3m(RGB 3in1, RGBW 4in 1 DMX512)</p> <p>Mounting sleeve:ABS.</p> <p>Dimmable Support:Triac/PWM/1-10V/DALI/DMX512</p>

MOUNTING

With Bracket

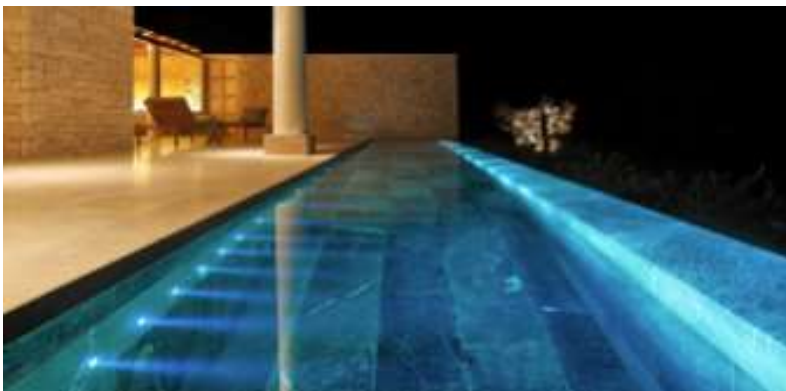

Name: SEAN LED B2

Code: D135

THORN

LED Pool Light

CE	RoHS	CRI>80/90	IP 68	IK 08	T _a -20 +40
-----------	-------------	-----------	-------	-------	---------------------------

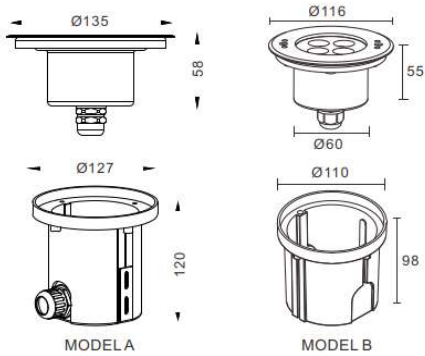

MODEL NO.	POWER	SYSTEM LUMEN	LED COLOR	BEAM ANGLE	INPUT VOLT	CONTROL
SEAN LED B2 D135	4x2W	30 lm/w	2700-6500K R/G/B	15°/30°/ 45°/ 60,45/35°	DC24V	DALI/1-10V Triac/PWM
SEAN LED B2 D135	4x3W	30 lm/w	RGB 3in1,DMX512		DC24V External DMX Chip	
SEAN LED B2 D135	4x4W	30 lm/w	RGBW 4in1,DMX512	15°/30°/45°/60°		
SEAN LED B2 D135	1x8W	75 lm/w	2700-6500K	24°/36°/60°	DC24V	

CUT HOLE	127*120mm(+3mm)
FINISH	<p>Front cover&Housing:Hard Chromeplated Molding Shaped Stainless steel SUS 316L#</p> <p>LED:CREE/OSRAM</p> <p>Lens: Optical lens, efficiency≥85%</p> <p>Glass:Step tempered glass.T=8mm</p> <p>Gasket:Tooling shaped seal</p> <p>Driver:Constant current output,Constant current output</p> <p>Power cable:H07RN-F 2X1.0mm2. L=3m(low voltage) H05RN-F 4X0.75mm2. L=3m(RGB) H05RN-F 5X0.5mm2. L=3m(RGB 3in1, RGBW 4in 1 DMX512)</p> <p>Mounting sleeve:ABS.</p> <p>Dimmable Support:Triac/PWM/1-10V/DALI/DMX512</p>

MOUNTING

Optional Cover Size

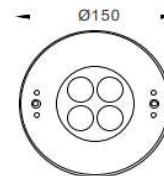

With Bracket



Name: SEAN LED B2

Code: R328x36

THORN

Underwater Spot Light

CE	RoHS	CRI>80/90	IP 68	IK 09	T_a -20 +40
----	------	-----------	-------	-------	------------------

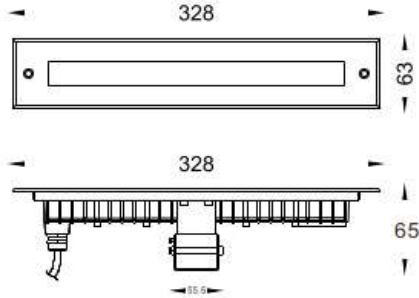

MODEL NO.	POWER	SYSTEM LUMEN	LED COLOR	BEAM ANGLE	INPUT VOLT	CONTROL
SEAN LED B2 R328x36	12W	30 lm/w	2700-6500K R/G/B	15°/30°/45°/60°	DC24V	DALI/0-10V Triac
SEAN LED B2 R328x36	18W	30 lm/w	RGB 3in1 DMX512		DC24V External DMX Chip	
SEAN LED B2 R328x36		30 lm/w	RGB 4in1 DMX512			

FINISH

Front cover&Housing:Hard Chromeplated Molding Shaped Stainless steel
SUS 316L#
LED:CREE/OSRAM
Lens: Optical lens, efficiency≥85%
Glass:Step tempered glass.T=8mm
Gasket:Tooling shaped seal
Driver:Constant current output,Constant current output
Power cable:H07RN-F 2X1.0mm2. L=3m(low voltage)
H05RN-F 4X0.75mm2. L=3m(RGB)
H05RN-F 5X0.5mm2. L=3m(RGB 3in1, RGBW 4in 1 DMX512)
Dimmable Support:Triac/PWM/1-10V/DALI/DMX512

MOUNTING

Underwater 1-3M



Ground Mounted

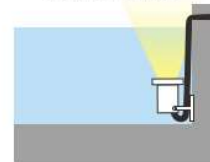

Wall Mounted



Name: SEAN LED B2

Code: R195x63

THORN

Underwater Spot Light

CE	RoHS	CRI>80/90	IP 68	IK 09	T_a -20 +40
----	------	-----------	-------	-------	------------------

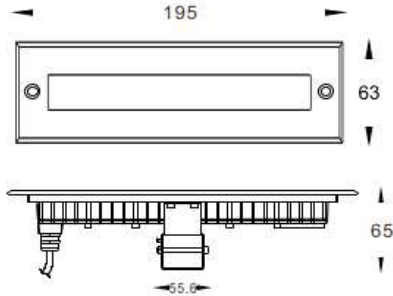

MODEL NO.	POWER	SYSTEM LUMEN	LED COLOR	BEAM ANGLE	INPUT VOLT	CONTROL
SEAN LED B2 R195x63	6W	30 lm/w	2700-6500K R/G/B	15°/30°/45°/60°	DC12V/24V	DALI/0-10V Triac
SEAN LED B2 R195x63	9W	30 lm/w	RGB 3in1 DMX512		DC24V External DMX Chip	
SEAN LED B2 R195x63		30 lm/w	RGB 4in1 DMX512			

FINISH

Front cover&Housing:Hard Chromeplated Molding Shaped Stainless steel
SUS 316L#
LED:CREE/OSRAM
Lens: Optical lens, efficiency≥85%
Glass:Step tempered glass.T=8mm
Gasket:Tooling shaped seal
Driver:Constant current output,Constant current output
Power cable:H07RN-F 2X1.0mm². L=3m(low voltage)
H05RN-F 4X0.75mm². L=3m(RGB)
H05RN-F 5X0.5mm². L=3m(RGB 3in1, RGBW 4in 1 DMX512)
Dimmable Support:Triac/PWM/1-10V/DALI/DMX512

MOUNTING

Underwater 1-3M



Ground Mounted

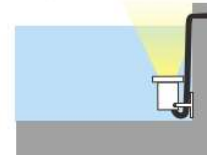

Wall Mounted



Name: SEAN LED B2

Code: D66

THORN

Underwater Spot Light

CE	RoHS	CRI>80/90	IP 68	IK 09	T_a -20 +40
-----------	-------------	-----------	-------	-------	------------------

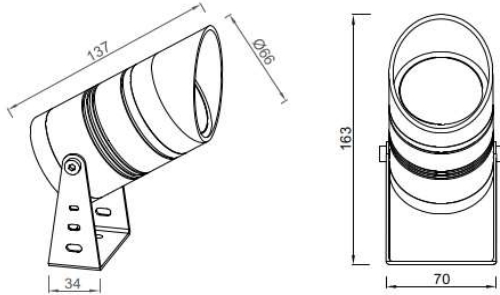

Physical Dimension(MM)



MODEL NO.	POWER	SYSTEM LUMEN	LED COLOR	BEAM ANGLE	INPUT VOLT	CONTROL
SEAN LED B2 D66	6-8W	80 lm/w	3000K-5700K	8°/12°/20°/30°/45° /60°/15°*30°/20°*60°	DC24V	DALI/0-10V Triac
SEAN LED B2 D66				10°/23°/38°		
SEAN LED B2 D66		30 lm/w	RGBW 4in1 DMX512	8°/12°/20°/30°/45° /60°/15°*30°/20°*60°		

FINISH

Front cover&Housing:CNC Stainless steel SUS 316L#
 Lens: Optical lens, efficiency>85%
 Glass:Step tempered glass.T=8mm
 Gasket:Tooling shaped seal
 Driver:Constant current output,Constant current output
 Dimmable Support:Triac/PWM/1-10V/DALI/DMX512

MOUNTING

Without Hood

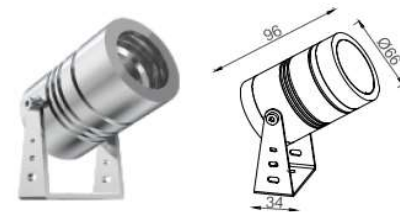

Underwater 1-3M

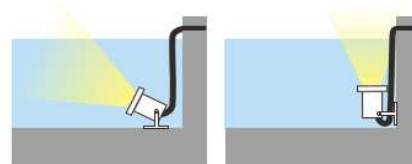

Ground Mounted

Wall Mounted

Name: SEAN LED B2

Code: D54

THORN

Underwater Spot Light

CE	RoHS	CRI>80/90	IP 68	IK 09	T_a -20 +40
-----------	-------------	-----------	-------	-------	------------------

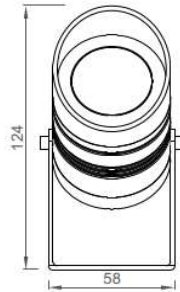
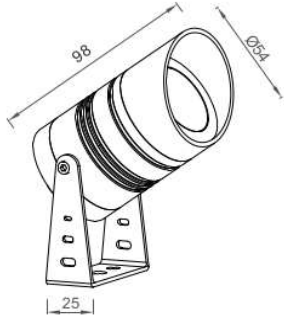

MODEL NO.	POWER	SYSTEM LUMEN	LED COLOR	BEAM ANGLE	INPUT VOLT	CONTROL
SEAN LED B2 D54	3-5W	80 lm/w	3000K-5700K	12°/15°/20°/25°/35°/60°	DC24V	DALI/0-10V Triac
SEAN LED B2 D54				18°/25°/35°		

FINISH	<p>Front cover&Housing:CNC Stainless steel SUS 316L#</p> <p>Lens: Optical lens, efficiency≥85%</p> <p>Glass:Step tempered glass.T=8mm</p> <p>Gasket:Tooling shaped seal</p> <p>Driver:Constant current output,Constant current output</p> <p>Dimmable Support:Triac/PWM/1-10V/DALI/DMX512</p>
---------------	---

MOUNTING

Without Hood

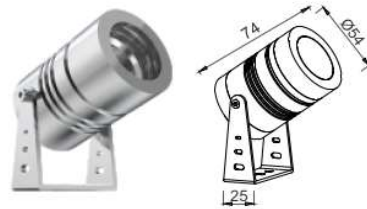

Underwater 1-3M

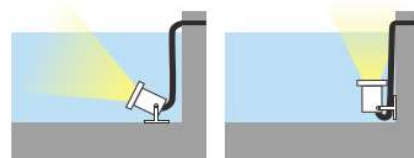

Ground Mounted

Wall Mounted



Name: SEAN LED B2

Code: D39

THORN

Underwater Spot Light

CE	RoHS	CRI>80/90	IP 68	IK 09	T_a -20 +40
----	------	-----------	-------	-------	------------------

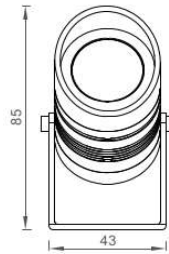
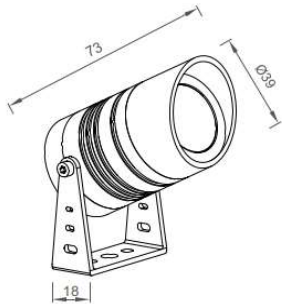

MODEL NO.	POWER	SYSTEM LUMEN	LED COLOR	BEAM ANGLE	INPUT VOLT	CONTROL
SEAN LED B2 D39	1-2W	80 lm/w	3000K-5700K	5°/8°/10° /12°/17° /30° /40°/60° /10°22°/ 15°55°	DC24V	DALI/0-10V Triac

FINISH	<p>Front cover&Housing:CNC Stainless steel SUS 316L#</p> <p>Lens: Optical lens, efficiency≥85%</p> <p>Glass:Step tempered glass.T=8mm</p> <p>Gasket:Tooling shaped seal</p> <p>Driver:Constant current output,Constant current output</p> <p>Dimmable Support:Triac/PWM/1-10V/DALI/DMX512</p>
---------------	---

MOUNTING

Without Hood

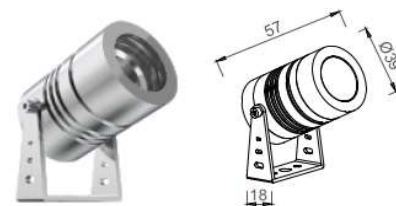

Underwater 1-3M

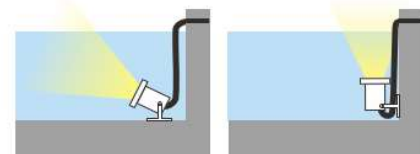

Ground Mounted

Wall Mounted



Name: SEAN LED B2

Code: D180

THORN

Underwater Spot Light

CE	RoHS	CRI>80/90	IP 68	IK 09	T_a -20 +40
-----------	-------------	-----------	-------	-------	------------------

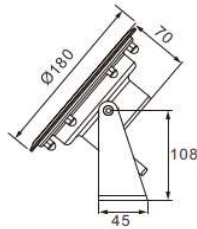
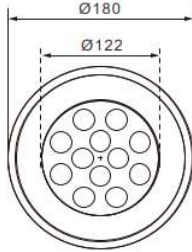

MODEL NO.	POWER	SYSTEM LUMEN	LED COLOR	BEAM ANGLE	INPUT VOLT	CONTROL
SEAN LED B2 D180	12W	30 lm/w	2800K-6500K/ RGB	15°/30°/45°/60°	AC/DC 12V/24V	DALI/0-10V Triac
SEAN LED B2 D180	18W	30 lm/w	2800K-6500K/ RGB/RGBW			
SEAN LED B2 D180	25W	30 lm/w	2800K-6500K/ RGB			

FINISH

Front cover&Housing:Hard Chromeplated Molding Shaped Stainless steel
 SUS 316L#/304L#
 LED:CREE/OSRAM
 Lens: Optical lens, efficiency≥85%
 Glass:Step tempered glass.T=8mm
 Gasket:Tooling shaped seal
 Driver:Constant current output,Constant current output
 Power cable:3X1.0mm². L=1.5m
 Dimmable Support:1-10V/DALI/DMX512

MOUNTING



Underwater 1-3M

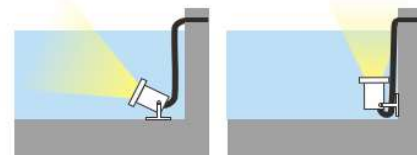

Ground Mounted

Wall Mounted

Name: SEAN LED B2

Code: D150

THORN

Underwater Spot Light

CE	RoHS	CRI>80/90	IP 68	IK 09	T_a -20 +40
----	------	-----------	-------	-------	------------------

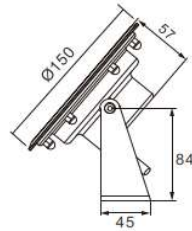
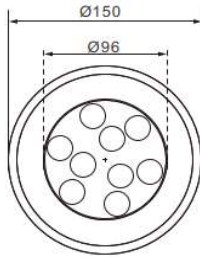

MODEL NO.	POWER	SYSTEM LUMEN	LED COLOR	BEAM ANGLE	INPUT VOLT	CONTROL
SEAN LED B2 D150	9W	30 lm/w	2800K-6500K/ RGB	15°/30°/45°/60°	AC/DC 12V/24V	DALI/0-10V Triac
SEAN LED B2 D150	18W	30 lm/w	2800K-6500K/ RGB/RGBW			

FINISH	<p>Front cover&Housing:Hard Chromeplated Molding Shaped Stainless steel SUS 316L#/304L# LED:CREE/OSRAM Lens: Optical lens, efficiency≥85% Glass:Step tempered glass.T=8mm Gasket:Tooling shaped seal Driver:Constant current output,Constant current output Power cable:3X1.0mm2. L=1.5m Dimmable Support:1-10V/DALI/DMX512</p>
---------------	---

MOUNTING



Underwater 1-3M

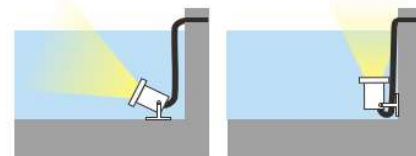

Ground Mounted

Wall Mounted

Name: SEAN LED B2

Code: D100UW

THORN

Underwater Spot Light

CE	RoHS	CRI>80/90	IP 68	IK 09	T _a -20 +40
----	------	-----------	-------	-------	---------------------------

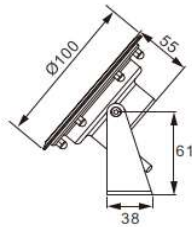
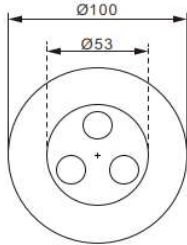

MODEL NO.	POWER	SYSTEM LUMEN	LED COLOR	BEAM ANGLE	INPUT VOLT	CONTROL
SEAN LED B2 D100UW	3W	30 lm/w	2800K-6500K/ RGB/RGBW	15°/30°/45°/60°	AC/DC 12V/24V	DALI/1-10V Triac/PWM
SEAN LED B2 D100UW	6W					

FINISH	<p>Front cover&Housing:Hard Chromeplated Molding Shaped Stainless steel SUS 316L#/304L# LED:CREE/OSRAM Lens: Optical lens, efficiency≥85% Glass:Step tempered glass.T=8mm Gasket:Tooling shaped seal Driver:Constant current output,Constant current output Power cable:3X1.0mm². L=1.5m Dimmable Support:1-10V/DALI/DMX512</p>
---------------	--

MOUNTING



Underwater 1-3M

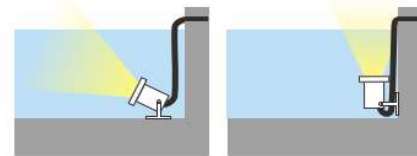

Ground Mounted

Wall Mounted

Name: SEAN LED B2

Code: D100

THORN

LED Pool Light

CE	RoHS	CRI>80/90	IP 68	IK 09	T_a -20 +40
-----------	-------------	-----------	-------	-------	------------------

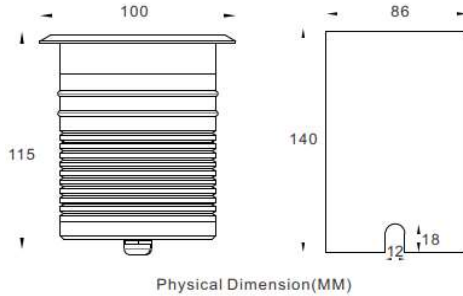

MODEL NO.	POWER	SYSTEM LUMEN	LED COLOR	BEAM ANGLE	INPUT VOLT	CONTROL
SEAN LED B2 D100	8-10W	30 lm/w	2200-6500K R/G/B/Y/A	5°/8°/10°/12° /25°/40°/60°	DC12V/DC24V /DC36V/DC48V	ON/OFF /0-10V/DALI/DMX512
SEAN LED B2 D100	8-10W	40 lm/w	Turnable White 2700K/6500k	25°/40°/60°	DC12V/DC24V	DMX512
SEAN LED B2 D100	8-10W	30 lm/w	RGB 3in1			
SEAN LED B2 D100	8-10W	30 lm/w	RGBW 4in1 (W: 2700K/3000K/4000K /5000K/5700K/6500K)			
SEAN LED B2 D100	8W/10W	80 lm/w	2700K-6500K	3°	DC12V/DC24V	ON/OFF /0-10V/DMX512
SEAN LED B2 D100	8W/10W			12°/24°/38°/45°/60° (Lens)		ON/OFF /0-10V/DMX512
SEAN LED B2 D100	8W/10W			15°/24°/38° (Reflector Cup)		ON/OFF /0-10V/DMX512

FINISH

Front cover&Housing:CNC Stainless steel SUS 316L#
 Lens: Optical lens, efficiency≥85%
 Glass:Step tempered glass.T=8mm
 Gasket:Tooling shaped seal
 Driver:Constant current output,Constant current output
 Power cable:H07RN-F 2X1.0mm2=3m(low voltage)
 Mounting sleeve:ABS.

MOUNTING



Square Cover Mounting Sleeve

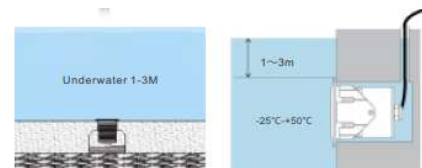
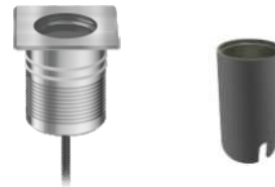

Ground Recessed

Wall Recessed

Name: SEAN LED B2

Code: D80

THORN

LED Pool Light

CE	RoHS	CRI>80/90	IP 68	IK 09	T_a -20 +40
----	------	-----------	-------	-------	------------------

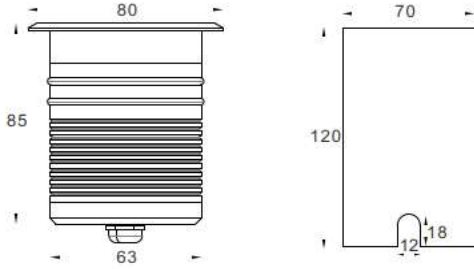

Physical Dimension(MM)



MODEL NO.	POWER	SYSTEM LUMEN	LED COLOR	BEAM ANGLE	INPUT VOLT	CONTROL
SEAN LED B2 D80	5W/7W	30 lm/w	2200-6500K R/G/B/Y/A	8°/12°/20°/30° /45°/60°	DC12V/DC24V /DC36V/DC48V	ON/OFF /0-10V/DALI/DMX512
SEAN LED B2 D80	5W/7W	40 lm/w	Turnable White 2700K/6500k	30°/45°/60°	DC24V/DC36V /DC48V	DMX512
SEAN LED B2 D80	5W/7W	30 lm/w	RGB 3in1			
SEAN LED B2 D80	5W/7W	30 lm/w	RGBW 4in1 (W: 2700K/3000K/4000K /5000K/5700K/6500K)			
SEAN LED B2 D80	5W/7W	30 lm/w	2200-6500K R/G/B/Y/A	6°	DC12V/DC24V /DC36V/DC48V	ON/OFF /0-10V/DALI/DMX512
SEAN LED B2 D80	5W/7W	80 lm/w	2700K-6500K	15°/24°/38° (Lens)		
SEAN LED B2 D80	5W/7W			15°/18°/34° (Reflector Cup)		

FINISH	<p>Front cover&Housing:CNC Stainless steel SUS 316L#</p> <p>Lens: Optical lens, efficiency≥85%</p> <p>Glass:Step tempered glass.T=8mm</p> <p>Gasket:Tooling shaped seal</p> <p>Driver:Constant current output,Constant current output</p> <p>Power cable:H07RN-F 2X1.0mm2=3m(low voltage)</p> <p>Mounting sleeve:ABS.</p>
---------------	---

MOUNTING



Square Cover

Mounting Sleeve

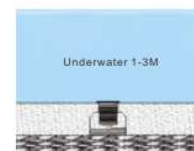

Ground Recessed

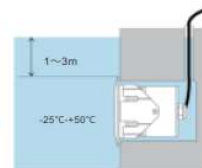

Wall Recessed

Name: SEAN LED B2

Code: D64

THORN

LED Pool Light

CE	RoHS	CRI>80/90	IP 68	IK 09	T_a -20 +40
----	------	-----------	-------	-------	------------------

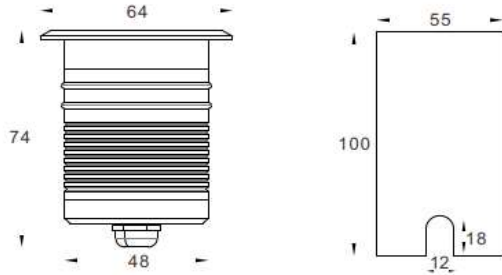

Physical Dimension(MM)

MODEL NO.	POWER	SYSTEM LUMEN	LED COLOR	BEAM ANGLE	INPUT VOLT	CONTROL
SEAN LED B2 D64	3-5W	80 lm/w	2700K-6500K	20°/40°	DC12V/DC24V	DMX512
SEAN LED B2 D64	3-5W	40 lm/w	Turnable White 2700K/6500k			
SEAN LED B2 D64	3-5W	30 lm/w	RGB 3in1			
SEAN LED B2 D64	3-5W	30 lm/w	RGBW 4in1			
SEAN LED B2 D64	3-5W	30 lm/w	2200-6500K R/G/B/Y/A	6°	DC12V/DC24V	ON/OFF /DMX512
SEAN LED B2 D64	3-5W	80 lm/w	2700K-6500K	15°/24°/38°/60° (Lens)	DC12V/DC24V	ON/OFF /DMX512
SEAN LED B2 D64	3-5W			18°/25°/35° (Reflector Cup)	DC12V/DC24V /DC36V/DC48V	ON/OFF /Triac /0-10V/DALI/DMX512

FINISH

Front cover&Housing:CNC Stainless steel SUS 316L#
 Lens: Optical lens, efficiency≥85%
 Glass:Step tempered glass.T=8mm
 Gasket:Tooling shaped seal
 Driver:Constant current output,Constant current output
 Power cable:H07RN-F 2X1.0mm2=3m(low voltage)
 Mounting sleeve:ABS.

MOUNTING

Square Cover

Mounting Sleeve

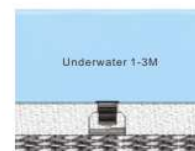

Ground Recessed

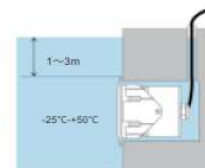

Wall Recessed

Name: SEAN LED B2

Code: D52

THORN

LED Pool Light

CE	RoHS	CRI>80/90	IP 68	IK 09	T_a -20 +40
-----------	-------------	-----------	-------	-------	------------------

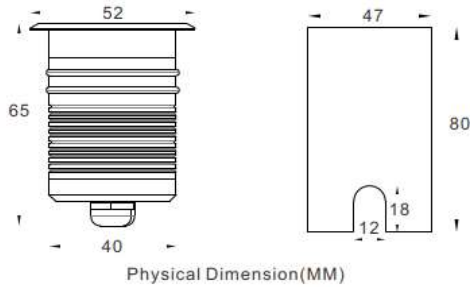

MODEL NO.	POWER	SYSTEM LUMEN	LED COLOR	BEAM ANGLE	INPUT VOLT	CONTROL
SEAN LED B2 D52	2.5W	30 lm/w	2200-6500K R/G/B/Y/A	5°/8°/10° /12°/25°/40°/60°	DC12V/DC24V /DC36V/DC48V	ON/OFF /Triac/0-10V/DALI
SEAN LED B2 D52	2-3W					DMX512
SEAN LED B2 D52	2W	40 lm/w	Turnable White 2700K/6500k	25°/40°/60°	DC12V/DC24V	DMX512
SEAN LED B2 D52	1.5W	30 lm/w	RGBW 4in1			
SEAN LED B2 D52	2.5W	30 lm/w	RGBW 4in1 (W: 2700K/3000K/4000K /5000K/5700K/6500K)		DC24V	
SEAN LED B2 D52	2-3W	80 lm/w	2700K-6500K	24°/36° (Reflector Cup)	DC12V/DC24V /DC36V/DC48V	ON/OFF /Triac /0-10V/DALI/DMX512

FINISH	<p>Front cover&Housing:CNC Stainless steel SUS 316L#</p> <p>Lens: Optical lens, efficiency≥85%</p> <p>Glass:Step tempered glass.T=8mm</p> <p>Gasket:Tooling shaped seal</p> <p>Driver:Constant current output,Constant current output</p> <p>Power cable:H07RN-F 2X1.0mm2=3m(low voltage)</p> <p>Mounting sleeve:ABS.</p>
---------------	---

MOUNTING

Square Cover

Mounting Sleeve

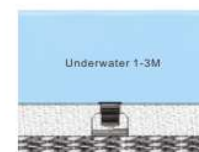

Ground Recessed

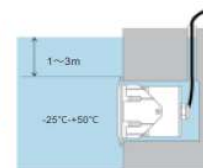

Wall Recessed

Name: SEAN LED B2

Code: D38

THORN

LED Pool Light

CE	RoHS	CRI>80/90	IP 68	IK 09	T_a -20 +40
-----------	-------------	-----------	-------	-------	------------------

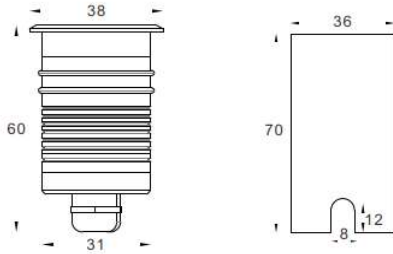

Physical Dimension(MM)



MODEL NO.	POWER	SYSTEM LUMEN	LED COLOR	BEAM ANGLE	INPUT VOLT	CONTROL
SEAN LED B2 D38	1-1.5W	30 lm/w	2200-6500K R/G/B/Y/A	12°/25°/40°/60°	DC12V/DC24V /DC36V/DC48V	ON/OFF /Triac/0-10V/DALI
SEAN LED B2 D38	2W					
SEAN LED B2 D38	2W	40 lm/w	Turnable White 2700K/6500k	25°/40°/60°	DC12V/DC24V	DMX512
SEAN LED B2 D38	1.5W	30 lm/w	RGBW 4in1			
SEAN LED B2 D38	2W	30 lm/w	RGBW 4in1 (W: 2700K/3000K/4000K /5000K/5700K/6500K)			

FINISH

Front cover&Housing:CNC Stainless steel SUS 316L#
 Lens: Optical lens, efficiency≥85%
 Glass:Step tempered glass.T=8mm
 Gasket:Tooling shaped seal
 Driver:Constant current output,Constant current output
 Power cable:H07RN-F 2X1.0mm2=3m(low voltage)
 Mounting sleeve:ABS.

MOUNTING

Square Cover

Mounting Sleeve



Ground Recessed

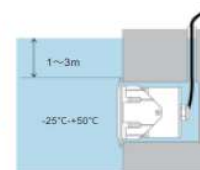

Wall Recessed

Name: SEAN LED B2

Code: D220.6F

THORN

LED Fountain Light

CE	RoHS	CRI>80/90	IP 68	IK 09	T_a -20 +40
-----------	-------------	-----------	-------	-------	------------------

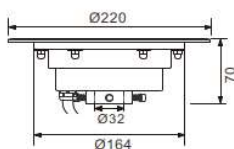
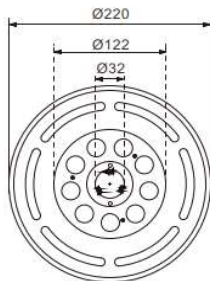

MODEL NO.	POWER	SYSTEM LUMEN	LED COLOR	BEAM ANGLE	INPUT VOLT	CONTROL
SEAN LED B2 D220.6F	6W	30 lm/w	2800K-6500K/ RGB	15°/30°/45°/60°	AC/DC 12V/24V	DALI/0-10V Triac
SEAN LED B2 D220.6F	9W		2800K-6500K/ RGB/RGBW			
SEAN LED B2 D220.6F	15W	40 lm/w	2800K-6500K/ RGB			

FINISH

Front cover&Housing:Hard Chromeplated Molding Shaped Stainless steel
 SUS 316L#
 LED:CREE/OSRAM
 Lens: Optical lens, efficiency≥85%
 Glass:Step tempered glass.T=8mm
 Gasket:Tooling shaped seal
 Driver:Constant current output,Constant current output
 Power cable:F 3X1.0mm². L=1.5m(low voltage)
 Dimmable Support:Triac/PWM/1-10V/DALI/DMX512

MOUNTING



Name: SEAN LED B2

Code: D220.12F

THORN

LED Fountain Light

CE	RoHS	CRI>80/90	IP 68	IK 09	T _a -20 +40
----	------	-----------	-------	-------	---------------------------

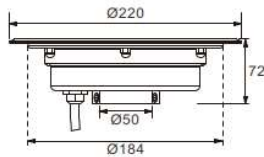
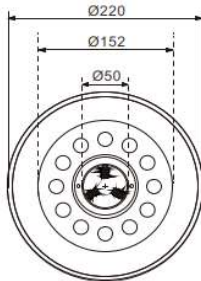

MODEL NO.	POWER	SYSTEM LUMEN	LED COLOR	BEAM ANGLE	INPUT VOLT	CONTROL
SEAN LED B2 D220.12F	12W	30 lm/w	2800K-6500K/ RGB/RGBW	15°/30°/45°/60°	AC/DC 12V/24V	DALI/0-10V Triac
SEAN LED B2 D220.12F	18W	30 lm/w	2800K-6500K/ RGB			

FINISH

Front cover&Housing:Hard Chromeplated Molding Shaped Stainless steel
SUS 316L#
LED:CREE/OSRAM
Lens: Optical lens, efficiency≥85%
Glass:Step tempered glass.T=8mm
Gasket:Tooling shaped seal
Driver:Constant current output,Constant current output
Power cable:F 3X1.0mm². L=1.5m(low voltage)
Dimmable Support:Triac/PWM/1-10V/DALI/DMX512

MOUNTING



Name: SEAN LED B2

Code: D200F

THORN

LED Fountain Light

CE	RoHS	CRI>80/90	IP 68	IK 09	T _a -20 +40
-----------	-------------	-----------	-------	-------	---------------------------

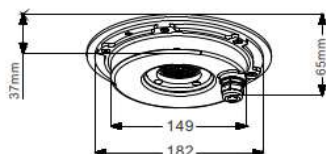
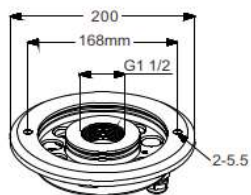

MODEL NO.	POWER	SYSTEM LUMEN	LED COLOR	BEAM ANGLE	INPUT VOLT	CONTROL
SEAN LED B2 D200F	24W	30 lm/w	2700-6500K R/G/B	15°/30°/45°/60°	DC24V	DALI/0-10V Triac
SEAN LED B2 D200F		30 lm/w	RGB			
SEAN LED B2 D200F	36W	30 lm/w	RGB 3in1 DMX512		DC24V External DMX Chip	
SEAN LED B2 D200F		30 lm/w	RGBW 4in1 DMX512			
SEAN LED B2 D200F	18W	30 lm/w	2700-6500K R/G/B		DC24V	
SEAN LED B2 D200F		30 lm/w	RGB			
SEAN LED B2 D200F	27W	30 lm/w	RGB 3in1 DMX512		DC24V External DMX Chip	
SEAN LED B2 D200F	36W	30 lm/w	RGBW 4in1 DMX512			

FINISH

Front cover&Housing:Hard Chromeplated Molding Shaped Stainless steel
SUS 316L#
LED:CREE/OSRAM
Lens: Optical lens, efficiency≥85%
Glass:Step tempered glass.T=8mm
Gasket:Tooling shaped seal
Driver:Constant current output,Constant current output
Power cable:H07RN-F 2X1.0mm². L=3m(low voltage)
H05RN-F 4X0.75mm². L=3m(RGB)
H05RN-F 5X0.5mm². L=3m(RGB 3in1, RGBW 4in 1 DMX512)
Dimmable Support:Triac/PWM/1-10V/DALI/DMX512

MOUNTING

Water Jet Pipe

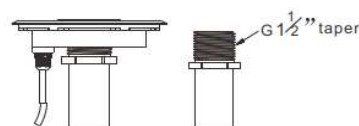

Name: SEAN LED B2

Code: D182F

THORN

LED Fountain Light

CE	RoHS	CRI>80/90	IP 68	IK 09	T_a -20 +40
----	------	-----------	-------	-------	------------------

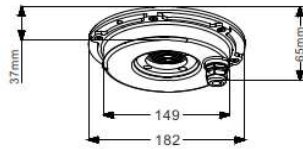
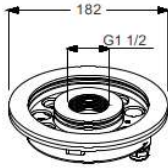

MODEL NO.	POWER	SYSTEM LUMEN	LED COLOR	BEAM ANGLE	INPUT VOLT	CONTROL
SEAN LED B2 D182F	18W	30 lm/w	2700-6500K R/G/B	15°/30°/45°/60°	DC24V	DALI/0-10V Triac
SEAN LED B2 D182F		30 lm/w	RGB			
SEAN LED B2 D182F	27W	30 lm/w	RGB 3in1 DMX512		DC24V External DMX Chip	
SEAN LED B2 D182F	36W	30 lm/w	RGBW 4in1 DMX512		DC24V	
SEAN LED B2 D182F	24W	30 lm/w	2700-6500K R/G/B			
SEAN LED B2 D182F		30 lm/w	RGB			
SEAN LED B2 D182F	36W	30 lm/w	RGB 3in1 DMX512		DC24V External DMX Chip	
SEAN LED B2 D182F		30 lm/w	RGBW 4in1 DMX512			

FINISH	<p>Front cover&Housing:Hard Chromeplated Molding Shaped Stainless steel SUS 316L#</p> <p>LED:CREE/OSRAM</p> <p>Lens: Optical lens, efficiency≥85%</p> <p>Glass:Step tempered glass.T=8mm</p> <p>Gasket:Tooling shaped seal</p> <p>Driver:Constant current output,Constant current output</p> <p>Power cable:H07RN-F 2X1.0mm². L=3m(low voltage)</p> <p style="padding-left: 40px;">H05RN-F 4X0.75mm². L=3m(RGB)</p> <p style="padding-left: 40px;">H05RN-F 5X0.5mm². L=3m(RGB 3in1, RGBW 4in 1 DMX512)</p> <p>Dimmable Support:Triac/PWM/1-10V/DALI/DMX512</p>
---------------	--

MOUNTING



Water Jet Pipe

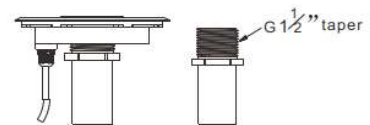

With Frame(Cover with Screw Hole)



Name: SEAN LED B2

Code: D170F

THORN

LED Fountain Light

CE	RoHS	CRI>80/90	IP 68	IK 09	T_a -20 +40
----	------	-----------	-------	-------	------------------

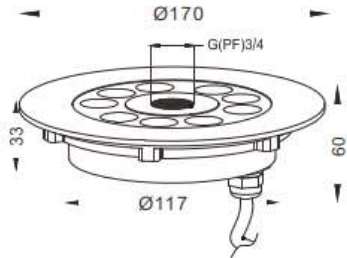

MODEL NO.	POWER	SYSTEM LUMEN	LED COLOR	BEAM ANGLE	INPUT VOLT	CONTROL
SEAN LED B2 D170F	18W	30 lm/w	2700-6500K R/G/B	15°/30°/45°/60°	DC24V	DALI/0-10V Triac
SEAN LED B2 D170F		30 lm/w	RGB			
SEAN LED B2 D170F	27W	30 lm/w	RGB 3in1 DMX512		DC24V External DMX Chip	
SEAN LED B2 D170F		30 lm/w	RGBW 4in1 DMX512			
SEAN LED B2 D170F	18W	30 lm/w	2700-6500K R/G/B		DC24V	
SEAN LED B2 D170F		30 lm/w	RGB			
SEAN LED B2 D170F	27W	30 lm/w	RGB 3in1 DMX512		DC24V External DMX Chip	
SEAN LED B2 D170F		30 lm/w	RGBW 4in1 DMX512			

FINISH	<p>Front cover&Housing:Hard Chromeplated Molding Shaped Stainless steel SUS 316L#</p> <p>LED:CREE/OSRAM</p> <p>Lens: Optical lens, efficiency≥85%</p> <p>Glass:Step tempered glass.T=8mm</p> <p>Gasket:Tooling shaped seal</p> <p>Driver:Constant current output,Constant current output</p> <p>Power cable:H07RN-F 2X1.0mm2. L=3m(low voltage) H05RN-F 4X0.75mm2. L=3m(RGB) H05RN-F 5X0.5mm2. L=3m(RGB 3in1, RGBW 4in 1 DMX512)</p> <p>Dimmable Support:Triac/PWM/1-10V/DALI/DMX512</p>
---------------	---

MOUNTING

Water Jet Pipe

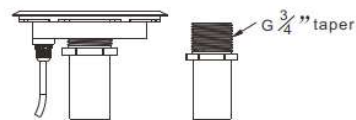

With Frame(Cover with Screw Hole)

