

Name: PAK LED B2

Code: R171x106

**THORN**

LED Stair&wall Light

	CE	RoHS	CRI>80/90	IP 65	IK 08	T <sub>a</sub> -20 +40
--	----	------	-----------	-------	-------	---------------------------

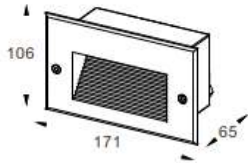

Physical Dimension(MM)

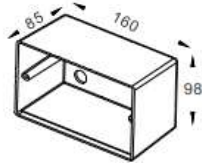

Mounting Sleeve(MM)



MODEL NO.	POWER	SYSTEM LUMEN	LED COLOR	BEAM ANGLE	INPUT VOLT	CONTROL
PAK LED B2 R171x106	2W	75 lm/w	2700K-6500K/R/G/B	120°	24V/12V DC 240V/120V AC	DALI/0-10V Triac

**CUT OUT:** 160\*85\*98mm

**FINISH**

LED:OSRAM.  
 Housing:12#Die-casting powder coated aluminum.T=60-80um.Adhesion of ISO class 1/ASTM class48.  
 LED Driver:Constant voltage input,Constant current output.  
 Gasket:Tooling shaped double silicone seal.  
 Dimmable:Triac/Dali/1-10V/PWM/DMX512.  
 Power Cable:H05RN--F 2X1.0mm2L=0.5M(low voltage).H05RN-F 3x0.75mm2L=0.5M(high voltage).H05RN-F 4x0.75mm2L=0.5M(RGB).H05RN-F 5  
 x0.75 mm2  
 L=0.5M(RGBW).  
 Working Temperature:-20 to 40°C.  
 Mounting Sleeve:ABS

**MOUNTING**

Optional Model/Painting Color

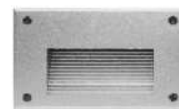

Name: PAK LED B2

Code: R106x171

**THORN**

LED Stair&wall Light

<b>CE</b>	<b>RoHS</b>	CRI>80/90	IP 65	IK 08	$T_a$ -20 +40
-----------	-------------	-----------	-------	-------	------------------

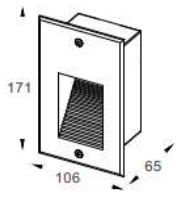

Physical Dimension(MM)

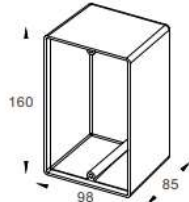

Mounting Sleeve(MM)



MODEL NO.	POWER	SYSTEM LUMEN	LED COLOR	BEAM ANGLE	INPUT VOLT	CONTROL
PAK LED B2 R106x171	1.5W	75 lm/w	2700K-6500K/R/G/B	120°	24V/12V DC 240V/120V AC	DALI/0-10V Triac

**CUT OUT:** 98\*85\*160mm

**FINISH**

LED:OSRAM.  
 Housing:12#Die-casting powder coated aluminum.T=60-80um.Adhesion of ISO class 1/ASTM class48.  
 LED Driver:Constant voltage input,Constant current output.  
 Gasket:Tooling shaped double silicone seal.  
 Dimmable:Triac/Dali/1-10V/PWM/DMX512.  
 Power Cable:H05RN-F 2X1.0mm2L=0.5M(low voltage).H05RN-F 3x0.75mm2L=0.5M(high voltage).H05RN-F 4x0.75mm2L=0.5M(RGB).H05RN-F 5  
 x0.75 mm2  
 L=0.5M(RGBW).  
 Working Temperature:-20 to 40°C.  
 Mounting Sleeve:ABS

**MOUNTING**

Optional Model/Painting Color



Name: PAK LED B2

Code: S120

**THORN**

LED Stair&wall Light

	<b>CE</b>	<b>RoHS</b>	CRI>80/90	IP 65	IK 08	T <sub>a</sub> -20 +40
--	-----------	-------------	-----------	-------	-------	---------------------------

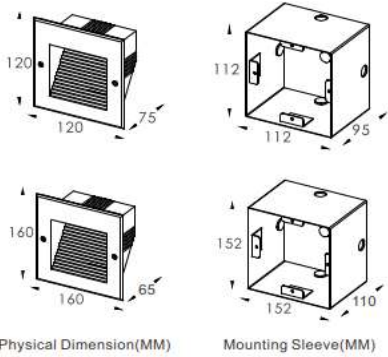

MODEL NO.	POWER	SYSTEM LUMEN	LED COLOR	BEAM ANGLE	INPUT VOLT	CONTROL
PAK LED B2 S120	1.5W	75 lm/w	2700K-6500K/R/G/B	120°	24V/12V DC 240V/120V AC	DALI/0-10V Triac
PAK LED B2 S120	2.5W	75 lm/w	2700K-6500K/R/G/B	120°	24V/12V DC 240V/120V AC	

<b>CUT OUT:</b> 98*85*160mm	
<b>FINISH</b>	<p>LED:OSRAM.                  Housing:12#Die-casting powder coated aluminum.T=60-80um.Adhesion of ISO class 1/ASTM class48.                  LED Driver:Constant voltage input,Constant current output.                  Gasket:Tooling shaped double silicone seal.                  Dimmable:Triac/Dali/1-10V/PWM/DMX512.                  Power Cable:H05RN--F 2X1.0mm2L=0.5M(low voltage),H05RN-F 3x0.75mm2L=0.5M(high voltage),H05RN-F 4x0.75mm2L=0.5M(RGB),H05RN-F 5 x0.75 mm2 L=0.5M(RGBW).                  Working Temperature:-20 to 40°C.                  Mounting Sleeve:ABS</p>

**MOUNTING**



Optional Cover& Finishing



Name: PAK LED B2

Code: D80

**THORN**

LED Stair&wall Light

CE	RoHS	CRI>80/90	IP 65	IK 08	T <sub>a</sub> -20 +40
----	------	-----------	-------	-------	---------------------------

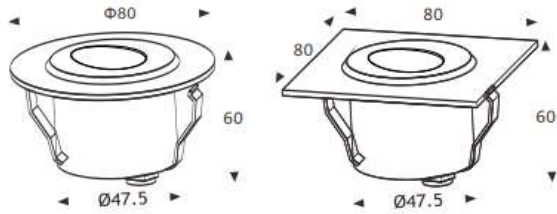

Physical Dimension(MM)



MODEL NO.	POWER	SYSTEM LUMEN	LED COLOR	BEAM ANGLE	INPUT VOLT	CONTROL
PAK LED B2 D80	1*2W	75 lm/w	2700K-6500K/R/G/B	80°	24V/12V DC 240V/120V AC	DALI/0-10V Triac
PAK LED B2 D80	1*3W	30 lm/w	RGB 3in1,DMX512		24V/12V DC	
PAK LED B2 D80	1*4W	30 lm/w	RGBW 4in1,DMX512			

<b>CUT OUT:</b> 71mm	
<b>FINISH</b>	<p>LED:OSRAM/CREE/EPISTAR.</p> <p>Housing:12#Die-casting powder coated aluminum.T=60-80um.Adhesion of ISO class 1/ASTM class48.</p> <p>LED Driver:Constant voltage input,Constant current output.</p> <p>Gasket:Tooling shaped double silicone seal.</p> <p>Dimmable:Triac/Dali/1-10V/PWM/DMX512.</p> <p>Power Cable:H05RN--F 2X1.0mm2L=0.5M(low voltage).H05RN-F3x0.75mm2L=0.5M(high voltage).H05RN-F4x0.75mm2L=0.5M(RGB).H05RN-F 5x0.75 mm2 L=0.5M(RGBW).</p> <p>Working Temperature:-20 to 40°C.</p> <p>Mounting Sleeve:ABS.</p>

**MOUNTING**

Optional Cover & Finishing Color

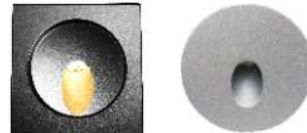

Mounting Sleeve(MM)



Name: PAK LED B2

Code: S95

**THORN**

LED Stair&wall Light

	<b>CE</b>	<b>RoHS</b>	<b>CRI&gt;80/90</b>	<b>IP 65</b>	<b>IK 08</b>	<b>T<sub>a</sub>-20 +40</b>
--	-----------	-------------	---------------------	--------------	--------------	---------------------------------

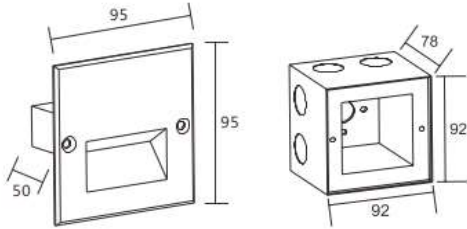

Physical Dimension(MM)



MODEL NO.	POWER	LUMEN	LED COLOR	BEAM ANGLE	INPUT VOLT	CONTROL
PAK LED B2 S95	1.5W	90 lm	2700K-6500K	30°	24VDC 240V/120VAC	DALI/0-10V Triac

**FINISH**

LED:OSRAM/CREE/EPISTAR.  
 Housing:12#Die-casting powder coated aluminum.T=60-80um.Adhesion of ISO class 1/ASTM class48.  
 Gasket:Tooling shaped double silicone seal.  
 Dimmable:Triac/Dali/1-10V/PWM/DMX512.  
 Power Cable:H05RN--F 2X1.0mm2L=0.5M(low voltage).H05RN-F3x0.75mm2L =0.5M(high voltage).  
 Working Temperature:-20 to 40°C.  
 Mounting Sleeve:ABS

**MOUNTING**

Optional Cover & Finishing Color



Name: PAK LED B2

Code: R145x45

**THORN**

LED Stair&wall Light

	<b>CE</b>	<b>RoHS</b>	<b>CRI&gt;80/90</b>	<b>IP 65</b>	<b>IK 08</b>	<b>T<sub>a</sub>-20 +40</b>
--	-----------	-------------	---------------------	--------------	--------------	---------------------------------

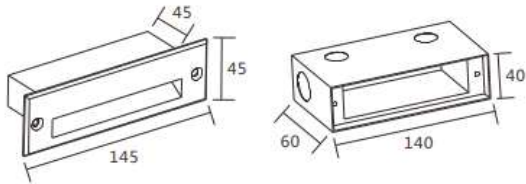

Physical Dimension(MM)



MODEL NO.	POWER	LUMEN	LED COLOR	BEAM ANGLE	INPUT VOLT	CONTROL
PAK LED B2 R145x45	1.5W	90 lm	2700K-6500K	120°	24VDC 240V/120VAC	DALI/0-10V Triac

**FINISH**

LED:OSRAM.  
 Housing:12#Die-casting powder coated aluminum.  
 Gasket:Tooling shaped double silicone seal.  
 Dimmable:Triac/Dali/1-10V/PWM/DMX512.  
 Power Cable:H05RN--F 2X1.0mm<sup>2</sup>L=0.5M(low voltage).H05RN-F 3x0.75mm<sup>2</sup>L=0.5M(high voltage).  
 Working Temperature:-20 to 40° C.  
 Mounting Sleeve:ABS.

**MOUNTING**

Optional Cover& Finishing

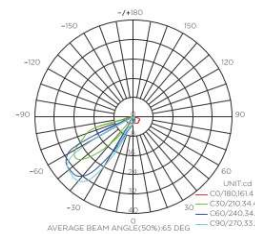

Name: PAK LED B2

Code: S102

**THORN**

LED Stair&wall Light

	<b>CE</b>	<b>RoHS</b>	CRI>80/90	IP 65	IK 08	T <sub>a</sub> -20 +40
--	-----------	-------------	-----------	-------	-------	---------------------------

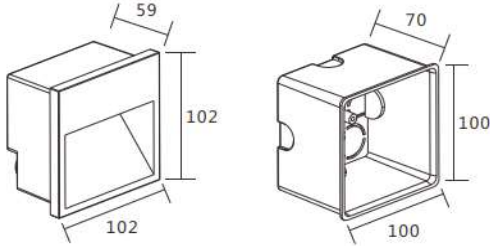

Physical Dimension(MM)



MODEL NO.	POWER	LUMEN	LED COLOR	BEAM ANGLE	INPUT VOLT	CONTROL
PAK LED B2 S102	3W	180lm	2700K-6500K	120°	24VDC 240V/120VAC	DALI/0-10V Triac

**FINISH**

LED:OSRAM/CREE/EPISTAR.  
Housing:12#Die-casting powder coated aluminum.  
LED Driver:Constant voltage input,Constant current output.  
Gasket:Tooling shaped double silicone seal.  
Dimmable:Triac/Dali/1-10V/PWM/DMX512.  
Power Cable:H05RN-F 2X1.0mm2L=0.5M(low voltage).H05RN-F3x0.75mm2L =0.5M(high voltage)  
Working Temperature:-20 to 40° C.  
Mounting Sleeve:ABS.

**MOUNTING**

Optional Model/Painting Color



Name: PAK LED B2

Code: D150

**THORN**

LED Stair&wall Light

	CE	RoHS	CRI>80/90	IP 65	IK 08	T <sub>a</sub> -20 +40
--	----	------	-----------	-------	-------	---------------------------

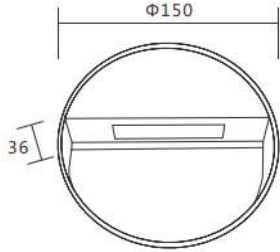

Physical Dimension(MM)



MODEL NO.	POWER	LUMEN	LED COLOR	BEAM ANGLE	INPUT VOLT	CONTROL
PAK LED B2 D150	6W	350lm	2700K-6500K	120°	24VDC 240V/120VAC	DALI/0-10V Triac

<b>FINISH</b>	<p>LED:OSRAM.                  Housing:12#Die-casting powder coated aluminum.                  Gasket:Tooling shaped double silicone seal.                  Dimmable:Triac/Dali/1-10V/PWM/DMX512.                  Power Cable:H05RN-F 2X1.0mm2L=0.5M(low voltage).H05RN-F 3x0.75mm2L=0.5M(high voltage)                  Working Temperature:-20 to 40° C.                  Mounting Sleeve:ABS.</p>
---------------	---

**MOUNTING**

Optional Cover& Finishing Color

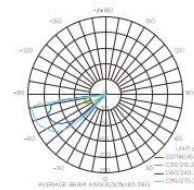



Name: PAK LED B2

Code: S150

**THORN**

LED Stair&wall Light

	CE	RoHS	CRI>80/90	IP 65	IK 08	T <sub>a</sub> -20 +40
--	----	------	-----------	-------	-------	---------------------------

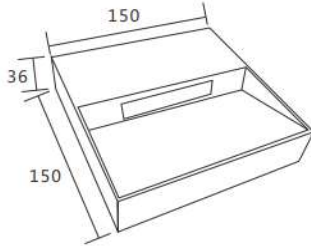

Physical Dimension(MM)



MODEL NO.	POWER	LUMEN	LED COLOR	BEAM ANGLE	INPUT VOLT	CONTROL
PAK LED B2 S150	6W	350 lm	2700K-6500K	120°	24VDC 240V/120VAC	DALI/0-10V Triac

<b>FINISH</b>	LED:OSRAM.
	Housing:12#Die-casting powder coated aluminum. Gasket:Tooling shaped double silicone seal. Dimmable:Triac/Dali/1-10V/PWM/DMX512. Power Cable:H05RN--F 2X1.0mm2L=0.5M(low voltage).H05RN-F 3x0.75mm2L=0.5M(high voltage) Working Temperature:-20 to 40° C. Mounting Sleeve:ABS.

**MOUNTING**



Optional Model/Painting Color

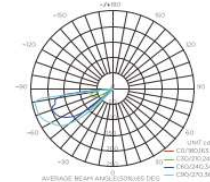

Name: PAK LED B2

Code: R200X90

**THORN**

LED Stair&wall Light

	CE	RoHS	CRI>80/90	IP 65	IK 08	T <sub>a</sub> -20 +40
--	----	------	-----------	-------	-------	---------------------------

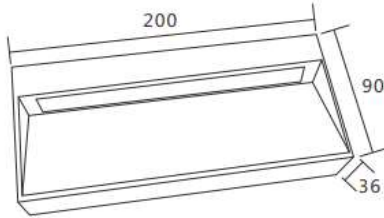

Physical Dimension(MM)

MODEL NO.	POWER	LUMEN	LED COLOR	BEAM ANGLE	INPUT VOLT	CONTROL
PAK LED B2 R200X90	6W	350lm	2700K-6500K	120°	24VDC 240V/120VAC	DALI/0-10V Triac

<b>FINISH</b>	LED:OSRAM.
	Housing:12#Die-casting powder coated aluminum.
	Gasket:Tooling shaped double silicone seal.
	Dimmable:Triac/Dali/1-10V/PWM/DMX512.
	Power Cable:H05RN--F 2X1.0mm2L=0.5M(low voltage).H05RN-F 3x0.75mm2L=0.5M(high voltage)
	Working Temperature:-20 to 40° C. Mounting Sleeve:ABS.

**MOUNTING**

Optional Cover& Finishing

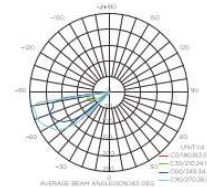

Name: PAK LED B2

Code: S215

**THORN**

LED Stair&wall Light

	<b>CE</b>	<b>RoHS</b>	CRI>80/90	IP 65	IK 08	T <sub>a</sub> -20 +40
--	-----------	-------------	-----------	-------	-------	---------------------------

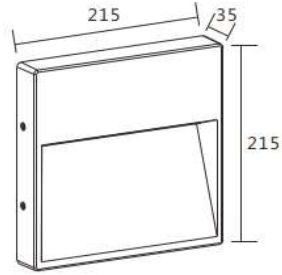

Physical Dimension(MM)



MODEL NO.	POWER	LUMEN	LED COLOR	BEAM ANGLE	INPUT VOLT	CONTROL
PAK LED B2 S215	9W	550lm	2700K-6500K	120°	24VDC 240V/120VAC	DALI/0-10V Triac

<b>FINISH</b>	LED:OSRAM.
	Housing:12#Die-casting powder coated aluminum.
	Gasket:Tooling shaped double silicone seal.
	Dimmable:Triac/Dali/1-10V/PWM/DMX512.
	Power Cable:H05RN--F 2X1.0mm2L=0.5M(low voltage).H05RN-F 3x0.75mm2L=0.5M(high voltage)
	Working Temperature:-20 to 40° C.
	Mounting Sleeve:ABS.

**MOUNTING**

Optional Model/Painting Color

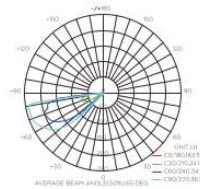

Name: PAK LED B2

Code: R200x110

# THORN

LED Stair&wall Light

	CE	RoHS	CRI>80/90	IP 65	IK 08	T <sub>a</sub> -20 +40
--	----	------	-----------	-------	-------	---------------------------

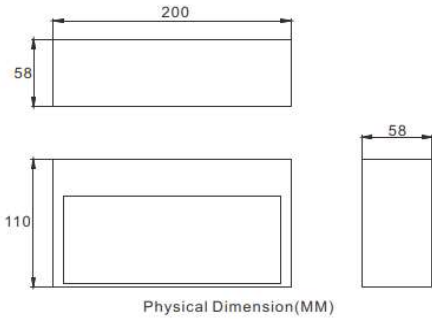

MODEL NO.	POWER	SYSTEM LUMEN	LED COLOR	BEAM ANGLE	INPUT VOLT	CONTROL
PAK LED B2 R200X110	13W	80 lm/w	2700K-4000K	120°	AC220-240V	DALI/0-10V Triac

<b>FINISH</b>	<i>LED:OSRAM/CREE. Housing:aluminum. Working Temperature:-20 to 40°C. Frequency Range:50/60HZ Life:&gt;50000H</i>
---------------	---



Optional Cover& Finishing Color

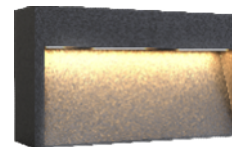

Name: PAK LED B2

Code: R320x220

# THORN

LED Stair&wall Light

	CE	RoHS	CRI>80/90	IP 65	IK 08	T <sub>a</sub> -20 +40
--	----	------	-----------	-------	-------	---------------------------

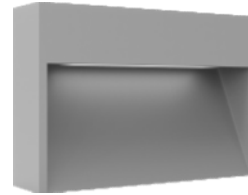
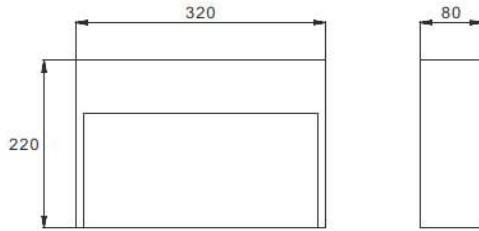

Physical Dimension(MM)

MODEL NO.	POWER	SYSTEM LUMEN	LED COLOR	BEAM ANGLE	INPUT VOLT	CONTROL
PAK LED B2 R320x220	17W	80 lm/w	2700K-4000K	120°	AC220-240V	DALI/0-10V Triac

<b>FINISH</b>	<i>LED:OSRAM/CREE. Housing:aluminum. Working Temperature:-20 to 40°C. Frequency Range:50/60HZ Life:&gt;50000H</i>
---------------	---



Optional Model/Painting Color

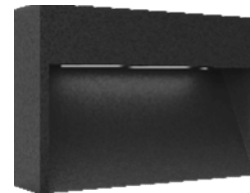

Name: PAK LED B2

Code: R230x102

# THORN

LED Stair&wall Light

	CE	RoHS	CRI>80/90	IP 65	IK 08	T <sub>a</sub> -20 +40
--	----	------	-----------	-------	-------	---------------------------

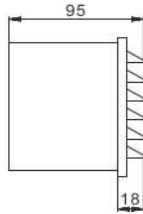
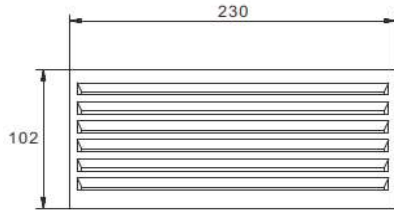

Physical Dimension(MM)

MODEL NO.	POWER	SYSTEM LUMEN	LED COLOR	BEAM ANGLE	INPUT VOLT	CONTROL
PAK LED B2 R230x102	10W	80 lm/w	2700K-4000K	120°	AC220-240V	DALI/0-10V Triac

**FINISH**

LED:OSRAM/CREE.  
Housing:aluminum.  
Working Temperature:-20 to 40°C.  
Frequency Range:50/60HZ  
Life:>50000H



Optional Cover& Finishing Color

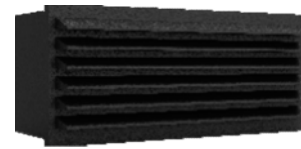

Name: PAK LED B2

Code: R220x80

# THORN

LED Stair&wall Light

	CE	RoHS	CRI>80/90	IP 65	IK 08	T <sub>a</sub> -20 +40
--	----	------	-----------	-------	-------	---------------------------

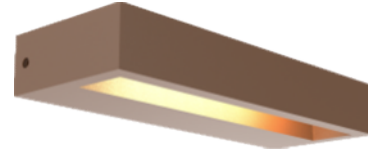
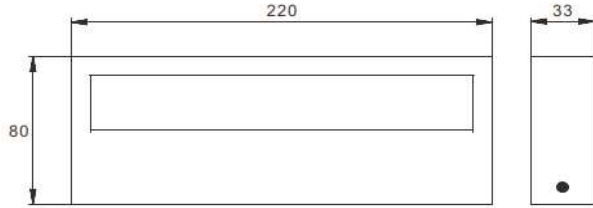

Physical Dimension(MM)

MODEL NO.	POWER	SYSTEM LUMEN	LED COLOR	BEAM ANGLE	INPUT VOLT	CONTROL
PAK LED B2 R220x80	11W	80 lm/w	2700K-4000K	120°	AC220-240V	DALI/0-10V Triac

<b>FINISH</b>	<i>LED:OSRAM/CREE. Housing:aluminum. Working Temperature:-20 to 40°C. Frequency Range:50/60HZ Life:&gt;50000H</i>
---------------	---



Optional Cover& Finishing  
Color

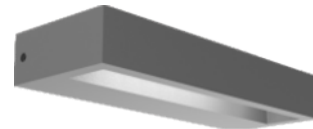

Name: PAK LED B2

Code: D65

**THORN**

LED Stair&wall Light

	CE	RoHS	CRI>80/90	IP 65	IK 08	T <sub>a</sub> -20 +40
--	----	------	-----------	-------	-------	---------------------------

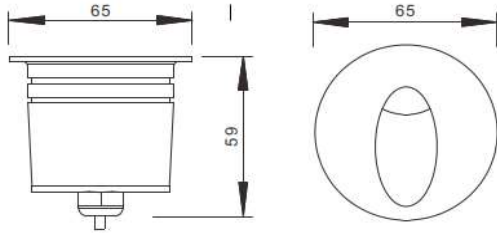

Physical Dimension(MM)



MODEL NO.	POWER	LUMEN	LED COLOR	BEAM ANGLE	INPUT VOLT	CONTROL
PAK LED B2 D65	2W	200 lm/w	2700K/3000K /4000K	Asymmetric	12/24V DC	DALI/0-10V Triac
PAK LED B2 D65						

**CUT OUT:** D52

**FINISH**

LED:CREE  
 Housing: CNC 6063# aluminum ,Matt silver/black anodized Finish or powder coated.  
 Lens: Optical lens , efficiency>85%.  
 Glass Cover: Tempered glass.  
 Driver: Constant current output,Constant current output.  
 Power Cable: H05RN-F 2\*1.0MM2 L=1M  
 Operating Temperature: -20°C ~ 40° C.  
 Dimmable Support:Triac/PWM/0-10V/DALI/DMX512.  
 Finish:Matt Silver/ Black Anodized.

**MOUNTING**

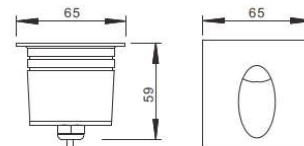



Name: PAK LED B2

Code: D45

**THORN**

LED Stair&wall Light

	CE	RoHS	CRI>80/90	IP 65	IK 08	T <sub>a</sub> -20 +40
--	----	------	-----------	-------	-------	---------------------------

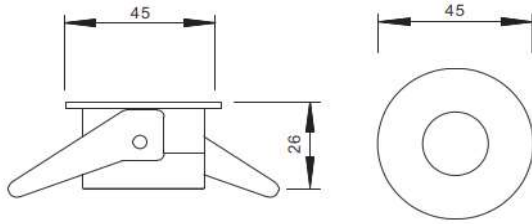

Physical Dimension(MM)



MODEL NO.	POWER	LUMEN	LED COLOR	BEAM ANGLE	INPUT VOLT	CONTROL
PAK LED B2 D45	1W	120lm	2700K/3000K /4000K	Asymmetric	350mA	DALI/0-10V Triac
PAK LED B2 D45						
PAK LED B2 D45						
PAK LED B2 D45						

**CUT OUT:** D40

LED:CREE

Housing: CNC 6063# aluminum ,Matt silver/black anodized Finish or powder coated.

Lens: Optical lens , efficiency>85%.

Glass Cover: Tempered glass.

**FINISH**

Driver: Constant current output,Constant current output.

Power Cable: H05RN-F 2\*1.0MM2 L=1M

Operating Temperature: -20°C ~ 40° C.

Dimmable Support: Triac/PWM/0-10V/DALI/DMX512.

Finish:Matt Silver/ Black Anodized.



Name: PAK LED B2

Code: D43

**THORN**

LED Stair&wall Light

CE	RoHS	CRI>80/90	IP 65	IK 08	$T_a$ -20 +40
----	------	-----------	-------	-------	------------------

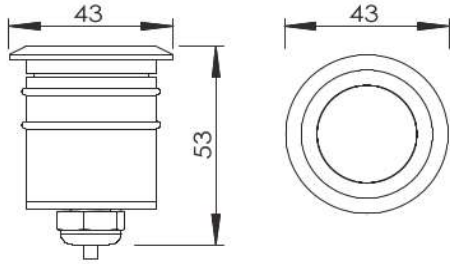

Physical Dimension(MM)



MODEL NO.	POWER	LUMEN	LED COLOR	BEAM ANGLE	INPUT VOLT	CONTROL
PAK LED B2 D43	0.5W	75lm	3000K-5000K R/G/B	40°	12V/24V/AC/DC	DALI/0-10V Triac
PAK LED B2 D43	1W	120lm	3000K-5000K R/G/B	24° 36°	12V/24V/AC/DC	

**FINISH**

LED:OSRAM/CREE.  
 Housing: CNC 6063# aluminum ,Matt silver/black anodized Finish or powder coated.  
 Lens: Optical lens , efficiency>85%.  
 Glass Cover: Tempered glass.  
 Driver: Constant current output,Constant current output.  
 Power Cable: H05RN-F 2\*1.0MM2 L=0.5M ( Low voltage).  
 Operating Temperature: -20°C~40°C.  
 Dimmable Support:Triac/PWM/0-10V/DALI/DMX512.  
 Finish:Matt Silver/ Black Anodized.

**MOUNTING**

Optional Cover& Finishing  
Color

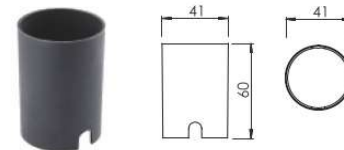

Mounting Sleeve(MM)



Name: PAK LED B2

Code: S64

**THORN**

LED Stair&wall Light

<b>CE</b>	<b>RoHS</b>	CRI>80/90	IP 65	IK 08	$T_a$ -20 +40
-----------	-------------	-----------	-------	-------	------------------

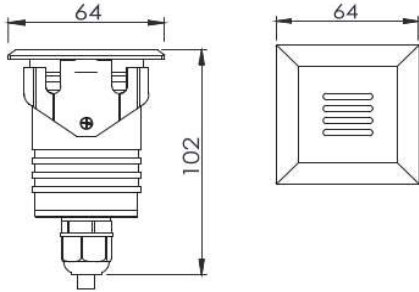

Physical Dimension(MM)



MODEL NO.	POWER	LUMEN	LED COLOR	BEAM ANGLE	INPUT VOLT	CONTROL
PAK LED B2 S64	3W	250lm	3000K-5000K R/G/B	40°	12V/24V AC/DC	DALI/0-10V Triac
PAK LED B2 S64	5W	550lm				

**FINISH**

LED:CREE/CITIZEN.  
 Housing: CNC 6063# aluminum ,Matt silver/black anodized Finish or powder coated.  
 Lens: Optical lens , efficiency>85%.  
 Glass Cover: Tempered glass.  
 Driver: Constant current output,Constant current output.  
 Power Cable: H05RN-F 2\*1.0MM2 L=0.5M ( Low voltage).  
 Operating Temperature: -20°C~40°C.  
 Dimmable Support:Triac/PWM/0-10V/DALI/DMX512.  
 Finish:Matt Silver/ Black Anodized

**MOUNTING**

Optional Cover& Finishing

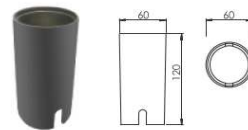

Mounting Sleeve(MM)



Name: PAK LED B2

Code: D62

**THORN**

LED Stair&wall Light

<b>CE</b>	<b>RoHS</b>	CRI>80/90	IP 65	IK 08	$T_a$ -20 +40
-----------	-------------	-----------	-------	-------	------------------

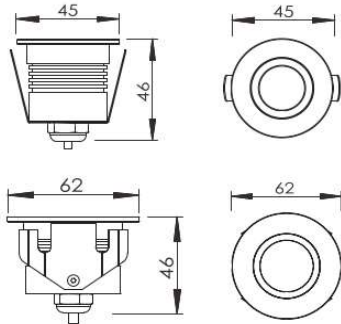

Physical Dimension(MM)



MODEL NO.	POWER	SYSTEM LUMEN	LED COLOR	CABLE LENGTH	INPUT VOLT	CUTOUT
PAK LED B2 D62	1W	80 lm/w	3000K	1m	24VDC	D40
PAK LED B2 D62	1W	80 lm/w	3000K	1m	24CDC	D51
PAK LED B2 D62	2W	80 lm/w	3000K	1m	24VDC	D51

**CONTROL:** DALI/0-10V Triac

**FINISH**

LED:CREE/CITIZEN.  
 Housing: CNC 6063# aluminum ,Matt silver/black anodized Finish or powder coated.  
 Lens: Optical lens , efficiency>85%.  
 Glass Cover: Tempered glass.  
 Driver: Constant current output,Constant current output.  
 Power Cable: H05RN-F 2\*1.0MM2 L=0.5M ( Low voltage).  
 Operating Temperature: -20 °C~40 °C.  
 Dimmable Support:Triac/PWM/0-10V/DALI/DMX512.  
 Finish:Matt Silver/ Black Anodized

**MOUNTING**



Optional Cover & Finishing Color

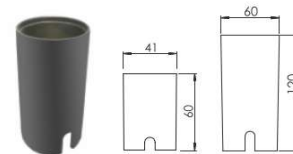
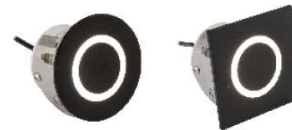

Mounting Sleeve(MM)