

MODULAR LINEAR SPOTLIGHT

CETUS

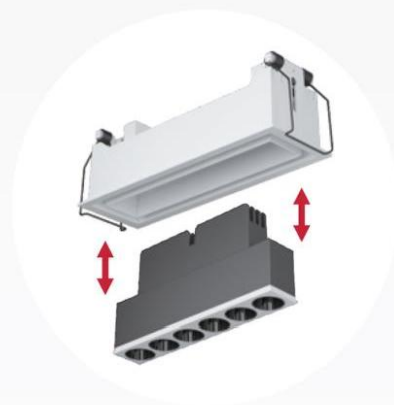

Detachable light source module

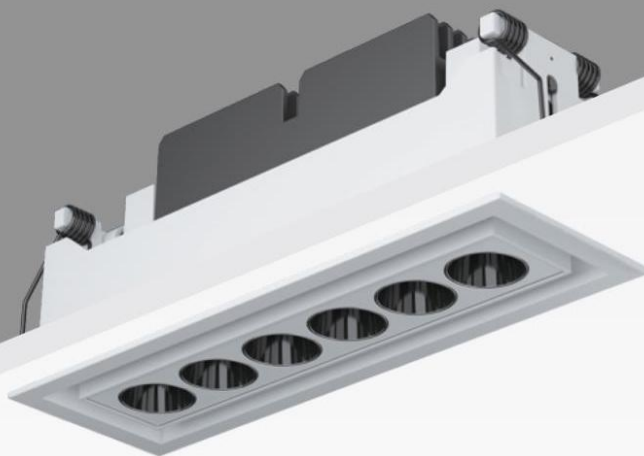

3 LED 5W



6 LED 10W



2*6 LED 2*10W

				CRI>80	CRI>90		<3 SDCM		CCT/ 3000K 4000K/5000K	
--	--	--	--	--------	--------	--	---------	--	---------------------------	--

Module

B1403S001 (5W)

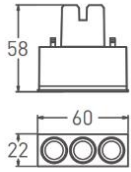

T1403S001



70*32*48mm
Hole Size 63*25mm

T1403S002



85*46*48mm
Hole Size 77*39mm

T1403ST01



65*64*48mm
Hole Size 67*36mm

T1403ST02



76*74*48mm
Hole Size 78*46mm

B1406S001(10W)

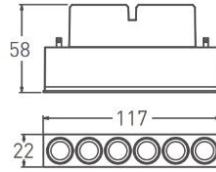

T1406S001



127*32*48mm
Hole Size 120*25mm

T1406S002



142*46*48mm
Hole Size 135*39mm

T1406ST01



122*64*48mm
Hole Size 124*36mm

T1406ST02



133*74*48mm
Hole Size 135*46mm

B1406S001(10W*2)

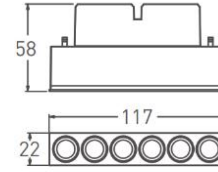

T1412S001



245*32*48mm
Hole Size 238*25mm

T1412S002



259*46*48mm
Hole Size 252*39mm

T1412ST01



239*64*48mm
Hole Size 241*36mm

T1412ST02



251*74*48mm
Hole Size 253*46mm

Housing kit

Name: CETUS C1

Modular Linear Spotlight



B1403S001

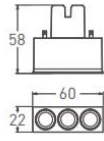

Global Lens Optics:

OSRAM *bridgelux*

5W
± 10% LED Current
DC 500mA



Flux: 300lm
CCT: 3000K
CRI: >90

Finish Black

B1406S001

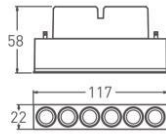

Global Lens Optics:

OSRAM *bridgelux*

10W
± 10% LED Current
DC 500mA



Flux: 700lm
CCT: 3000K
CRI: >90



Finish Black

Name: CETUS C1

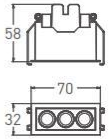

Modular Linear Spotlight

				CRI>80	CRI>90		<3 SDCM		CCT/ 3000K 4000K/5000K	
--	--	--	--	--------	--------	--	---------	--	---------------------------	--



D1403S001

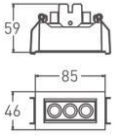

D1403S002

D1403ST01

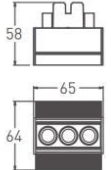
D1403ST02

Global Lens Optics:

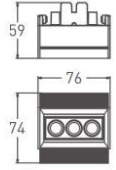
OSRAM *bridgelux*

5W
± 10% LED Current
DC 500mA

20° 40°

Flux: 300lm
CCT: 3000K
CRI: > 90

Finish  Black  White

Name: CETUS C1

Modular Linear Spotlight

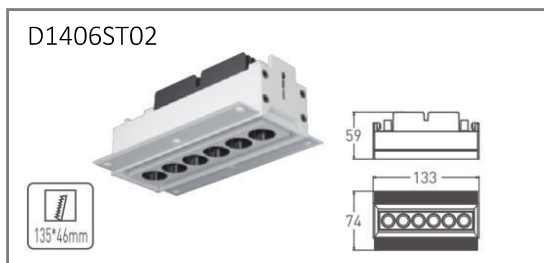
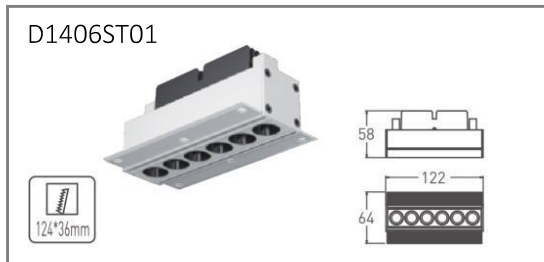
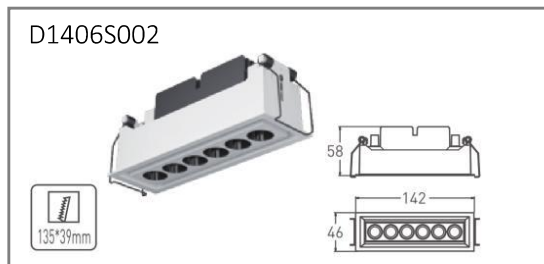
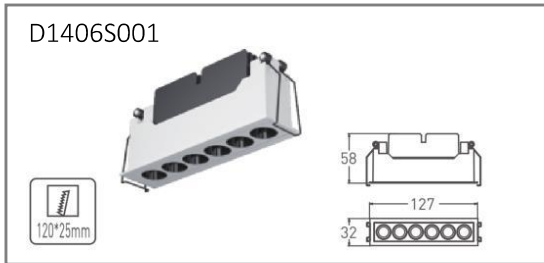

Global Lens Optics:

OSRAM *bridgelux*

10W
± 10% LED Current
DC 500mA

20° 40°

Flux: 700lm
CCT: 3000K
CRI: >90

Finish Black White

Name: CETUS C1

Modular Linear Spotlight

				CRI>80	CRI>90		<3 SDCM		CCT/ 3000K 4000K/5000K	
--	--	--	--	--------	--------	--	---------	--	---------------------------	--

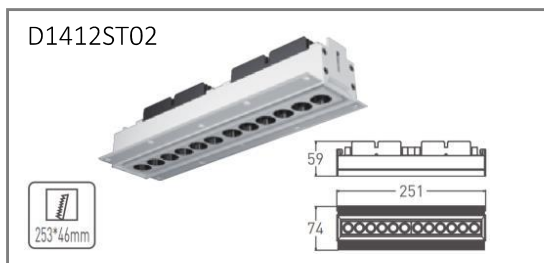
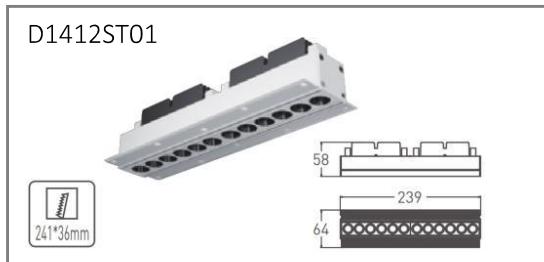
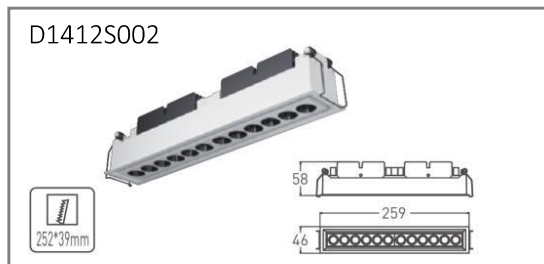
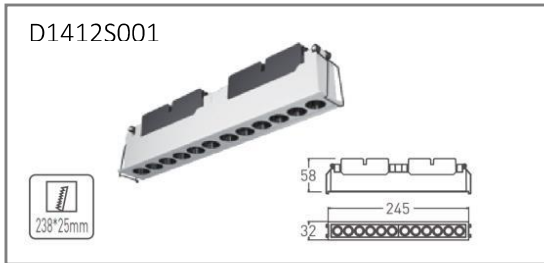

Global Lens Optics:

OSRAM *bridgelux*

20W
± 10%
LED Current
DC 500mA

20° 40°

Flux: 1350lm
CCT: 3000K
CRI: >90

Finish  Black  White

Name: CETUS C1

Grille light

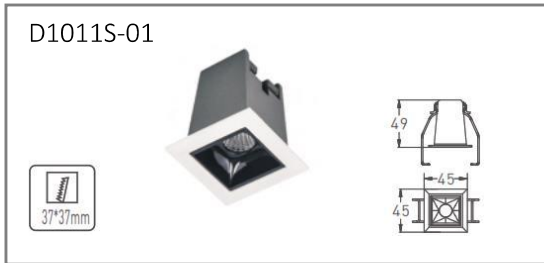
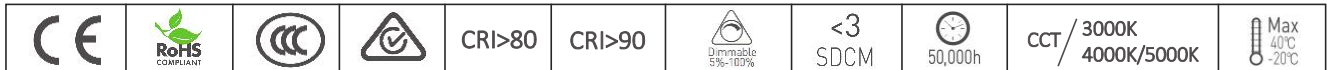

Global Lens Optics:

OSRAM *bridgelux*

2W
± 10% LED
Current
DC 500mA



Flux: 150lm
CCT: 3000K
CRI: >90

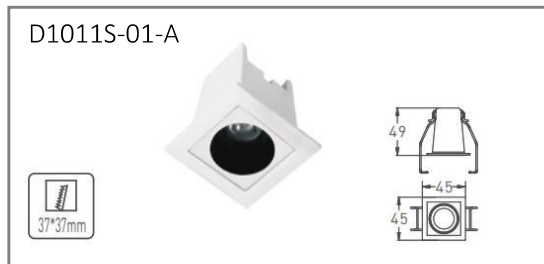

2W
± 10% LED
Current
DC 500mA



Flux: 150lm
CCT: 3000K
CRI: >90

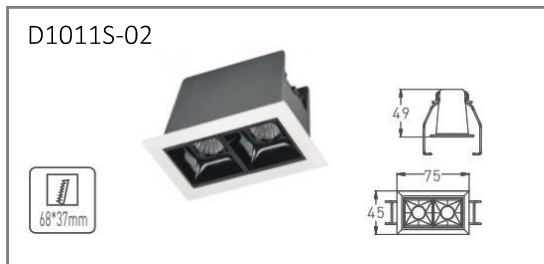

4W
± 10% LED
Current
DC 500mA



Flux: 200lm
CCT: 3000K
CRI: >90

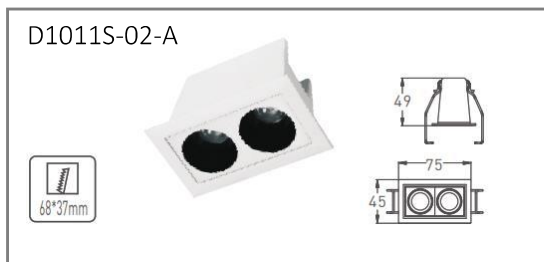

4W
± 10% LED
Current
DC 500mA



Flux: 200lm
CCT: 3000K
CRI: >90

Finish



Black



White

Name: CETUS C1

Grille light

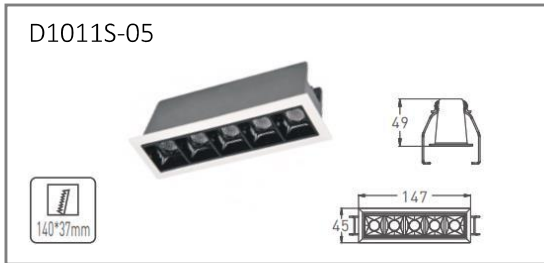
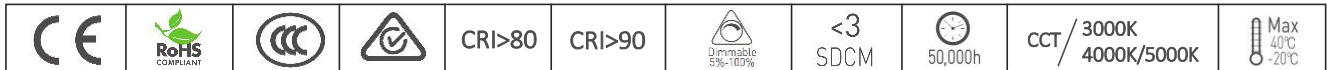

Global Lens Optics:

OSRAM bridgelux

10W
± 10% LED Current
DC 600mA

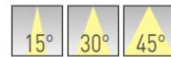

Flux: 800lm
CCT: 3000K
CRI: >90

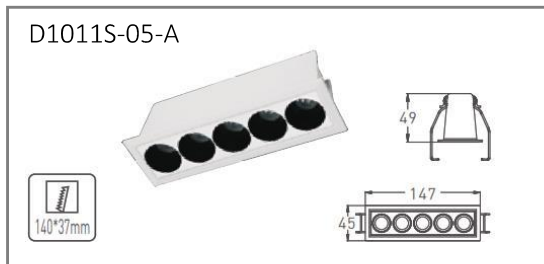

10W
± 10% LED Current
DC 600mA



Flux: 800lm
CCT: 3000K
CRI: >90

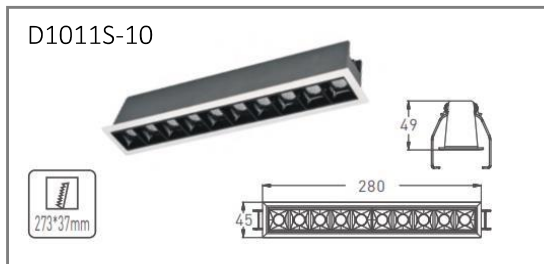

20W
± 10% LED Current
DC 600mA



Flux: 1600lm
CCT: 3000K
CRI: >90

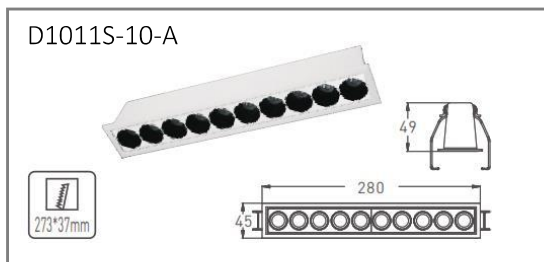

20W
± 10% LED Current
DC 600mA



Flux: 1600lm
CCT: 3000K
CRI: >90

Finish



Black



White

Name: CETUS C1

Grille light

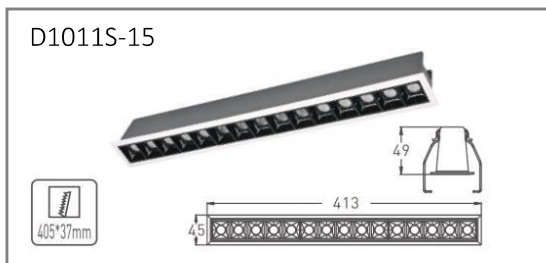
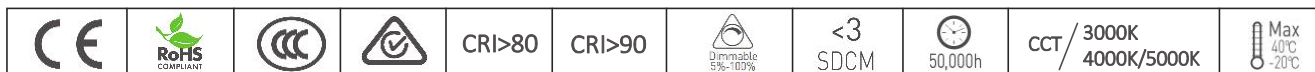

Global Lens Optics:

OSRAM *bridgelux*

30W
± 10% LED Current
DC 600mA

15° 30° 45°

Flux: 2400lm
CCT: 3000K
CRI: >90

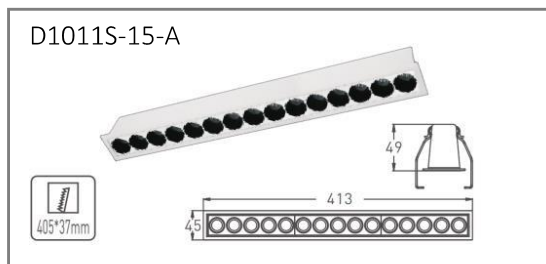

30W
± 10% LED Current
DC 600mA

15° 24° 36°

Flux: 2400lm
CCT: 3000K
CRI: >90



Finish Black White

Name: CETUS C1

Grille light



Global Lens Optics:

OSRAM *bridgelux*

10W
± 10%

LED
Current
DC 600mA

Wall
wash

Flux: 500lm

CCT: 3000K
CRI: >90

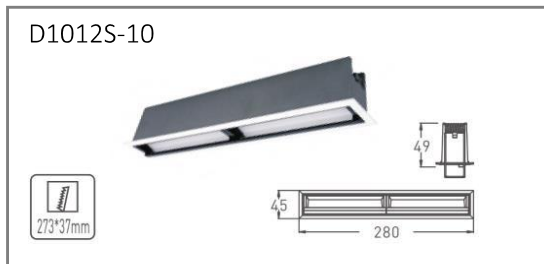

20W
± 10%

LED
Current
DC 600mA

Wall
wash

Flux: 1000lm

CCT: 3000K
CRI: >90

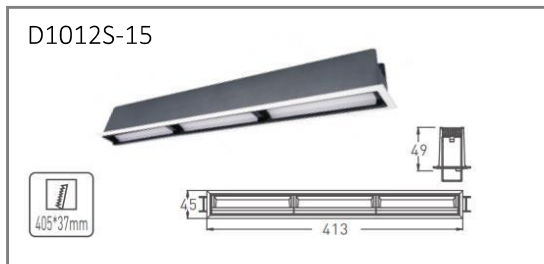

30W
± 10%

LED
Current
DC 600mA

Wall
wash

Flux: 1500lm

CCT: 3000K
CRI: >90

Finish



Black



White

Name: CETUS C1

Grille light

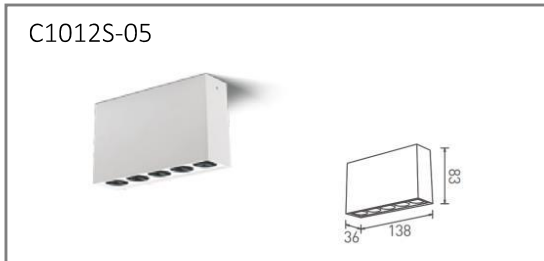

Global Lens Optics:

OSRAM *bridgelux*

10W
± 10% LED Current
DC 600mA

15° 24° 36°

Flux: 800lm
CCT: 3000K
CRI: >90

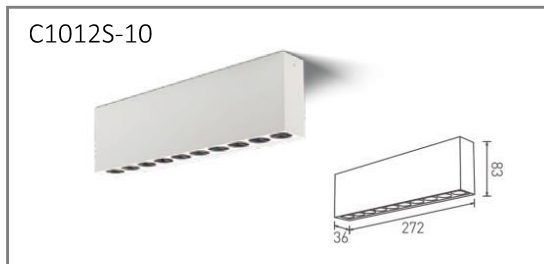

20W
± 10% LED Current
DC 600mA

15° 24° 36°

Flux: 1600lm
CCT: 3000K
CRI: >90

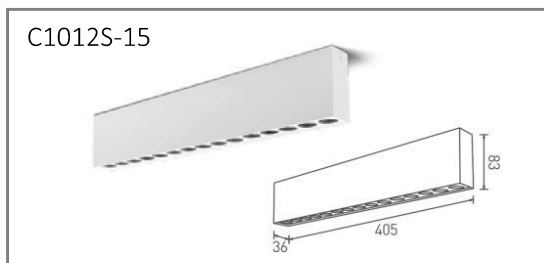

30W
± 10% LED Current
DC 600mA

15° 24° 36°

Flux: 2400lm
CCT: 3000K
CRI: >90

Finish



Black



White